

ROTONDO RANGE 1/2" TAPPINGS

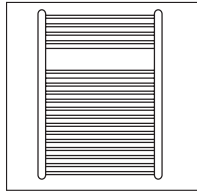

MRR

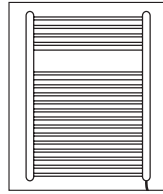

ERR

Optional Heater Kit – MHK500 260960

Heater kit increases height by 60mm and c/c tappings by + or - 70mm

Additional towel rail increases projection by 152mm

Sealed electric versions BEAB Approved to EN 60 335-2-43

	Cat No. White	Cat No. Chrome	Btu/hr at 50°C Temp. Diff. EN 442	Optional Additional Towel Rail	Overall Width	Overall Height	Width c/c Vertical Tubes	c/c Tappings	Overall Projection	Wall to Centre Tapping	Tube Size
MRR1/45	260705	260706	1317	260943	450	760	418	418	Adjustable 86-98	Adjustable 70-82	Frame 31.75mm diameter Cross tubes 25.4mm diameter
MRR1	260700	260701	1454	260940	500	760	468	468			
MRR2	260710	260711	1726	260941	600	760	568	568			
MRR3	260720	260721	2136	260942	750	760	718	718			
MRR4/45	260735	260736	1911	260943	450	1190	418	418			
MRR4	260730	260731	2119	260940	500	1190	468	468			
MRR5	260740	260741	2535	260941	600	1190	568	568			
MRR6	260750	260751	3163	260942	750	1190	718	718			
MRR7/45	260765	260766	2876	260943	450	1800	418	418			
MRR7	260760	260761	3187	260940	500	1800	468	468			
MRR8	260770	260771	3801	260941	600	1800	568	568			
MRR9	260780	260781	4739	260942	750	1800	718	718			
ERR300	260953	260954	Rated 500W	260940	500	780	468	N/A			

Optional sealed electric versions, right hand electrical connection as standard, left hand available on request.

M R S RANGE 1/2" TAPPINGS

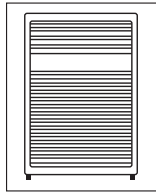

MRS

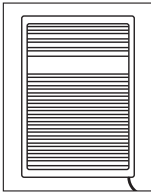

EMR

Optional Heater Kit – MHK500 260960

Heater kit increases height by 60mm and c/c tappings by + or - 70mm

Additional towel rail increases projection by 152mm

Sealed electric versions BEAB Approved to EN 60 335-2-43

	Cat No. White	Cat No. Chrome	Btu/hr at 50°C Temp. Diff. EN 442	Optional Additional Towel Rail	Overall Width	Overall Height	Width c/c Vertical Tubes	c/c Tappings	Overall Projection	Wall to Centre Tapping	Tube Size
MRS1/45	260805	260806	1338	260943	450	760	418	418	Adjustable 86-98	Adjustable 70-82	Frame 31.75mm square Cross tubes 25.4mm diameter
MRS1	260800	260801	1471	260940	500	760	468	468			
MRS2	260810	260811	1737	260941	600	760	568	568			
MRS3	260820	260821	2139	260942	750	760	718	718			
MRS4/45	260835	260836	1948	260943	450	1190	418	418			
MRS4	260830	260831	2170	260940	500	1190	468	468			
MRS5	260840	260841	2607	260941	600	1190	568	568			
MRS6	260850	260851	3265	260942	750	1190	718	718			
MRS7/45	260865	260866	2852	260943	450	1800	418	418			
MRS7	260860	260861	3177	260940	500	1800	468	468			
MRS8	260870	260871	3821	260941	600	1800	568	568			
MRS9	260880	260881	4797	260942	750	1800	718	718			
EMR750	260950	260951	Rated 500W	260940	500	780	468	N/A			

Optional sealed electric versions, right hand electrical connection as standard, left hand available on request.

ALOHA CURVED RANGE 1/2" TAPPINGS

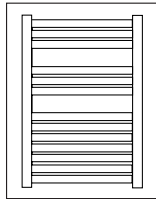

CMR

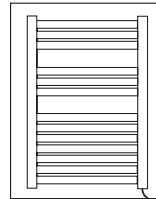

ECM

Optional Heater Kit – MHK500 260960

Heater kit increases height by 60mm and c/c tappings by + or - 70mm

Sealed electric versions BEAB Approved to EN 60 335-2-43

	Cat No. White	Cat No. Chrome	Btu/hr at 50°C Temp. Diff. EN 442	Optional Additional Towel Rail	Overall Width	Overall Height	Width c/c Vertical Tubes	c/c Tappings	Overall Projection	Wall to Centre Tapping	Tube Size
CMR1/45	260670	260671	1000	NOT AVAILABLE	450	725	393	396	Adjustable 120-135	Adjustable 71-86	Frame D shaped 40 x 30 Cross tubes Oval 30 x 20
CMR1	260680	260690	1102		500	725	443	446			
CMR2	260681	260691	1303		600	725	543	546			
CMR3	260682	260692	1607		750	725	693	696			
CMR4/45	260673	260674	1686		450	1195	393	396			
CMR4	260683	260693	1856		500	1195	443	446			
CMR5	260684	260694	2201		600	1195	543	546			
CMR6	260685	260695	2713		750	1195	693	696			
CMR7/45	260676	260677	2668		450	1853	393	396			
CMR7	260686	260696	2941		500	1853	443	446			
CMR8	260687	260697	3487		600	1853	543	546			
CMR9	260688	260698	4303		750	1853	693	696			

Optional sealed electric versions, right hand electrical connection as standard, left hand available on request.

CLASSIC RANGE 3/4" TAPPINGS

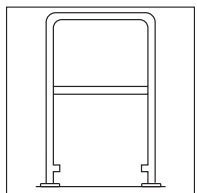

ES1

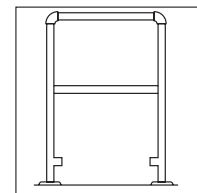

S1

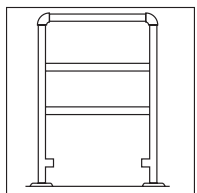

S2

	Cat No.	Btu/hr at 60°C Temp. Diff. EN 442	Width over Flange	Height over Flange	Width c/c Vertical Tubes	Face to Face of Tapping	Floor to Centre of Tapping	Pipe Centres for valves*	Overall Projection	Wall to Centre Tapping	Tube Diameter
ES1/1	260062	564	686	927	610	550	110	450	Dependent upon Wall Stays		25.4
ES1/2	260063	587	838	927	762	702	110	602			25.4
ES1/3	264270	606	990	927	914	854	110	754			25.4
S1/1	260050 CB	548	686	927	610	550	110	450	Dependent upon Wall Stays		25.4
S1/2	260000 CB	606	838	927	762	702	110	602			25.4
S1/3	264290	659	990	927	914	854	110	754			25.4
S1/4	264295	659	693	930	610	540	110	440			31.75
S1/5	264300	727	845	930	762	692	110	592			31.75
S1/6	264305	791	997	930	914	844	110	744			31.75
S2/1	260010	659	686	927	610	550	110	450	Dependent upon Wall Stays		25.4
S2/2	260011 CB	743	838	927	762	702	110	602			25.4
S2/3	264320	829	990	927	914	854	110	754			25.4
S2/4	264325	791	693	930	610	540	110	440			31.75
S2/5	264330	894	845	930	762	692	110	592			31.75
S2/6	260055 CB	992	997	930	914	844	110	744			31.75

*Using Myson Towel Warmer Valves

All dimensions are in mm

Optional sealed electric and dual fuel versions, right hand electrical connection as standard, left hand available on request. Element protrudes 57mm beyond flange.

Cat No. for Chrome finish. CB = Center Brand and includes adjustable wall stays.

CLASSIC RANGE 3/4" TAPPINGS (CONTINUED)

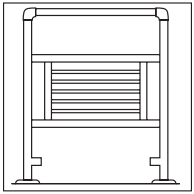

S6

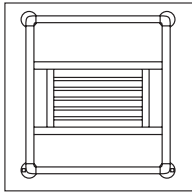

S11

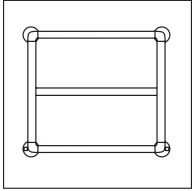

S14

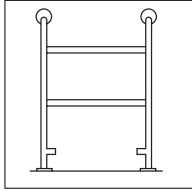

CYG3

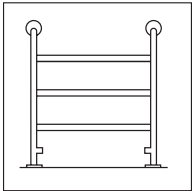

CYG4

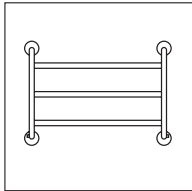

CYG14

Optional sealed electric and dual fuel versions, right hand electrical connection as standard, left hand available on request. Element protrudes 57mm beyond flange.
 Cat No. for Chrome finish. CB = Center Brand.

	Cat No.	Btu/hr at 60°C Temp. Diff. EN 442	Width over Flange	Height over Flange	Width c/c Vertical Tubes	Face to Face of Tapping	Floor to Centre of Tapping	Pipe Centres for valves*	Overall Projection	Wall to Centre Tapping	Tube Diameter
S6/1	260060	1499	693	930	610	540	110	440	Dependent upon Wall Stays		31.75
S6/2	260061	1598	845	930	762	692	110	592		31.75	
S6/3	264350	1698	997	930	914	844	110	744		31.75	
S6/4	264335	1798	1150	930	1067	997	110	897		31.75	
S11/1	264370	1570	693	693	610	680	N/A	780	135	58	31.75
S11/2	264375	1700	845	845	762	832	N/A	932	135	58	31.75
S11/3	264380	1870	997	845	914	984	N/A	1084	135	58	31.75
S11/4	264385	1980	1150	845	1067	1137	N/A	1237	135	58	31.75
S14/1	264400	659	686	686	610	670	N/A	770	130	58	25.4
S14/2	260021CB	743	838	686	762	822	N/A	922	130	58	25.4
S14/3	264410	829	990	686	914	974	N/A	1074	130	58	25.4
S14/4	264415	882	990	838	914	974	N/A	1074	130	58	25.4
S14/5	264420	791	693	693	610	680	N/A	780	135	58	31.75
S14/6	264425	894	845	693	762	832	N/A	932	135	58	31.75
S14/7	264427	992	997	693	914	984	N/A	1084	135	58	31.75
S14/8	264429	1057	997	845	914	984	N/A	1084	135	58	31.75
CYG3/1	264430	560	686	953	610	550	110	450	115	102	25.4
CYG3/2	264435	620	838	953	762	702	110	602	115	102	25.4
CYG3/3	264440	675	990	953	914	854	110	754	115	102	25.4
CYG4/1	264460	675	686	953	610	550	110	450	115	102	25.4
CYG4/2	264465	760	838	953	762	702	110	602	115	102	25.4
CYG4/3	264470	850	990	953	914	854	10	754	115	102	25.4
CYG14/1	264479	626	686	686	610	670	N/A	770	140	58	25.4
CYG14/2	264449	706	838	686	762	822	N/A	922	140	58	25.4
CYG14/3	264483	787	991	686	914	990	N/A	1074	140	58	25.4
CYG14/4	264486	838	991	838	914	990	N/A	1074	140	58	25.4

PREMIER RANGE 3/4" TAPPINGS

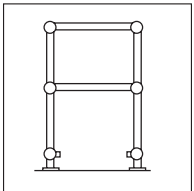

B21

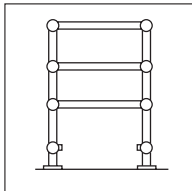

B22

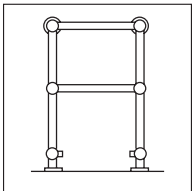

B23

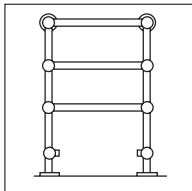

B24

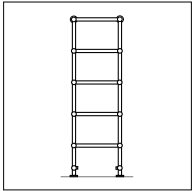

B25

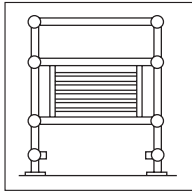

B26

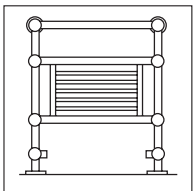

B27

	Cat No.	Btu/hr at 60°C Temp. Diff. EN 442	Width over Flange	Height over Flange	Width c/c Vertical Tubes	Face to Face of Tapping	Floor to Centre of Tapping	Pipe Centres for valves*	Overall Projection	Wall to Centre Tapping	Tube Diameter
B21/1	264000	565	686	932	610	550	110	450	Dependent upon Wall Stays		25.4
B21/2	264005	624	838	932	762	702	110	602		25.4	
B21/3	264010	679	990	932	914	854	110	754		25.4	
B21/4	264015	679	693	937	610	550	110	450		31.75	
B21/5	264020	749	845	937	762	702	110	602		31.75	
B21/6	264025	815	997	937	914	854	110	754		31.75	
B22/1	264030	679	686	932	610	550	110	450	Dependent upon Wall Stays		25.4
B22/2	264035	765	838	932	762	702	110	602		25.4	
B22/3	264040	854	990	932	914	854	110	754		25.4	
B22/4	264045	815	693	937	610	550	110	450		31.75	
B22/5	264050	920	845	937	762	702	110	602		31.75	
B22/6	264055	1022	997	937	914	854	110	754		31.75	
B23/1	264060	565	686	953	610	550	110	450	135	114	25.4
B23/2	264065	624	838	953	762	702	110	602	135	114	25.4
B23/3	264070	679	990	953	914	854	110	754	135	114	25.4
B23/4	264075	679	693	955	610	550	110	450	135	114	31.75
B23/5	264080	749	845	955	762	702	110	602	135	114	31.35
B23/6	264085	815	997	955	914	854	110	754	135	114	31.75
B24/1	264090	679	686	953	610	550	110	450	135	114	25.4
B24/2	264095	765	838	953	762	702	110	602	135	114	25.4
B24/3	264100	854	990	953	914	854	110	754	135	114	25.4
B24/4	264105	815	693	955	610	550	110	450	140	114	31.75
B24/5	264110	920	845	955	762	702	110	602	140	114	31.75
B24/6	264115	1022	997	955	914	854	110	754	140	114	31.75
B25/1	264117	900	540	1566	457	397	110	297	140	114	31.75
B25/2	264118	1030	693	1566	610	550	110	450	140	114	31.75
B25/3	264119	1165	845	1566	762	702	110	602	140	114	31.75
B26/1	264120	1543	693	937	610	550	110	450	Dependent upon Wall Stays		31.75
B26/2	264125	1646	845	937	762	702	110	602		31.75	
B26/3	264130	1749	997	937	914	854	110	754		31.75	
B26/4	264135	1854	1150	937	1067	1007	110	907		31.75	
B27/1	264150	1543	693	955	610	550	110	450	140	114	31.75
B27/2	264155	1646	845	955	762	702	110	602	140	114	31.75
B27/3	264160	1749	997	955	914	854	110	754	140	114	31.75
B27/4	264165	1854	1150	955	1067	1007	110	907	140	114	31.75

*Using Myson Towl Warmer Valves

All dimensions are in mm

Optional sealed electric and dual fuel versions, right hand electrical connection as standard, left hand available on request. Element protrudes 57mm beyond flange. Cat No. for Chrome finish.

PREMIER RANGE 3/4" TAPPINGS (CONTINUED)



B29

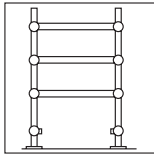

B30

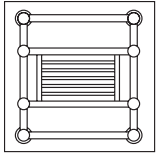

B31

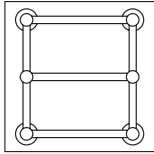

B34

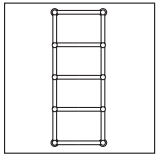

B35

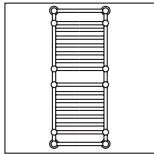

B36

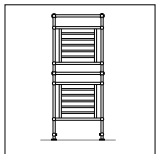

B47

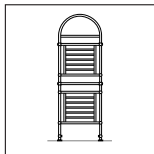

B49

	Cat No.	Btu/hr at 60°C Temp. Diff. EN 442	Width over Flange	Height over Flange	Width c/c Vertical Tubes	Face to Face of Tapping	Floor to Centre of Tapping	Pipe Centres for valves*	Overall Projection	Wall to Centre Tapping	Tube Diameter
B29	264180	1832	693	1040	610	N/A	N/A	610	125	50	31.75
B30	264190	1665	693	991	610	550	110	450	221	N/A	31.75
B31/1	264200	1570	693	693	610	670	N/A	770	140	58	25.4
B31/2	264205	1700	845	845	762	822	N/A	922	140	58	25.4
B31/3	264210	1870	997	845	914	974	N/A	1074	140	58	25.4
B31/4	264215	1980	1150	845	1067	1127	N/A	1227	140	58	25.4
B34/1	264230	679	686	686	610	670	N/A	770	135	58	25.4
B34/2	264235	765	838	686	762	822	N/A	922	135	58	25.4
B34/3	264240	854	990	686	914	974	N/A	1074	135	58	25.4
B34/4	264245	909	990	838	914	974	N/A	1074	135	58	25.4
B34/5	264250	815	693	693	610	670	N/A	770	140	58	31.75
B34/6	264255	920	845	693	762	822	N/A	922	140	58	31.75
B34/7	264257	1022	997	693	914	974	N/A	1074	140	58	31.75
B34/8	264258	1089	997	845	914	974	N/A	1227	140	58	31.75
B35/1	264450	770	540	1302	457	N/A	N/A	457	140	58	31.75
B35/2	264451	900	693	1302	610	N/A	N/A	610	140	58	31.75
B35/3	264452	1035	845	1302	762	N/A	N/A	762	140	58	31.75
B36/1	264454	1575	540	1302	457	N/A	N/A	457	140	58	31.75
B36/2	264455	1995	693	1302	610	N/A	N/A	610	140	58	31.75
B47/1	264457	2700	693	1737	610	550	110	450	140	114	31.75
B47/2	264458	2900	845	1737	762	702	110	602	140	114	31.75
B49	264459	2800	693	1867	610	550	110	450	140	114	31.75

Optional sealed electric and dual fuel versions, right hand electrical connection as standard, left hand available on request. Element protrudes 57mm beyond flange. [Cat No. for Chrome finish.](#)

VR RANGE 3/4" TAPPINGS

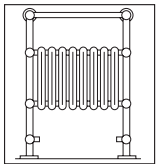

VR

	Cat No.	Btu/hr at 60°C Temp. Diff.	Width over Flange	Height over Flange	Width c/c Vertical Tubes	Face to Face of Tapping	Floor to Centre of Tapping	Pipe Centres for valves*	Overall Projection	Wall to Centre of Tapping	Tube Diameter	Radiator Hgt x Wth
VR1/4	264487	2170	476	952	393	333	110	233	205	105	31.75	500x4sec
VR1	260660	3493	678	952	595	535	110	435	205	105	31.75	500x8sec
VR2	260661	4154	780	952	697	637	110	537	205	105	31.75	500x10sec
VR3	260662	4788	882	952	799	739	110	639	205	105	31.75	500x12sec

Optional sealed electric and dual fuel versions, right hand electrical connection as standard, left hand available on request. Element protrudes 57mm beyond flange. [Cat No. for Chrome finish.](#)

RADIATOR RANGE 3/4" TAPPINGS

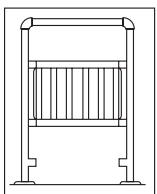

RS

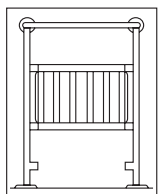

RPW

	Cat No.	Btu/hr at 60°C Temp. Diff.	Width over Flange	Height over Flange	Width c/c Vertical Tubes	Face to Face of Tapping	Floor to Centre of Tapping	Pipe Centres for valves*	Overall Projection	Wall to Centre of Tapping	Tube Diameter	Radiator Hgt x Wth
RS1	260600	1371	698	927	622	562	110	462	Dependent upon Wall Stays		25.4	385x490
RS2	260601	1782	857	927	781	721	110	621				385x645
RS3	260602	2015	1016	927	940	880	110	780				385x743
RS4	260603	1615	698	927	622	562	110	462				525x440
RS5	260604	2173	857	927	781	721	110	621				525x645
RS6	260605	2454	1016	927	940	880	110	780				525x745

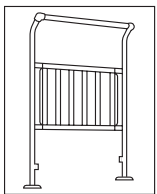

CB

RPW1	260030	1426	698	952	622	562	110	462	190	114	25.4	385x490
RPW2	260031	1837	857	952	781	721	110	621	190	114	25.4	385x645
RPW3	260032	2070	1016	952	940	880	110	780	190	114	25.4	385x743
RPW4	260033	1671	698	952	622	562	110	462	190	114	25.4	525x440
RPW5	260034	2229	857	952	781	721	110	621	190	114	25.4	525x645
RPW6	260035	2510	1016	952	940	880	110	780	190	114	25.4	525x745

	260110CB	1371	698	927	622	562	110	462	Dependent upon Wall Stays		25.4	385x490
	260111CB	1782	857	927	781	721	110	621				385x645
	260116CB	2015	1016	927	940	880	110	780				525x743

[Cat No. for Chrome finish.](#) CB = Center Brand and includes adjustable wall stays.

RADIATOR RANGE 1/2" TAPPINGS

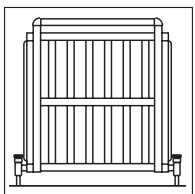

MTR

	Cat No.	Btu/hr at 60°C Temp. Diff.	Width over Flange	Height over Flange	Width c/c Vertical Tubes	Face to Face of Tapping	Floor to Centre of Tapping	Pipe Centres for valves*	Overall Projection	Wall to Centre of Tapping	Tube Diameter	Radiator Hgt x Wth
MTR1	260040	1504	440	655	N/A	415	N/A	495	130	50	25.4	524x440
MTR2	260041	2090	640	655	N/A	620	N/A	700	130	50	25.4	524x640
MTR3	260042	2399	745	655	N/A	720	N/A	800	130	50	25.4	524x745
MTR4	260043	2877	745	809	N/A	720	N/A	800	150	50	25.4	688x745
MTR5	260044	3247	850	809	N/A	820	N/A	900	150	50	25.4	688x850

*Using Myson Towel Warmer Valves. [Cat No. for Chrome finish.](#)

All dimensions are in mm

ELECTRIC RANGE

EO RANGE BEAB APPROVED TO EN 60 335-2-43

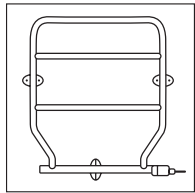

EO 90 & EO 150

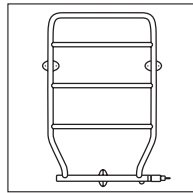

EO 130

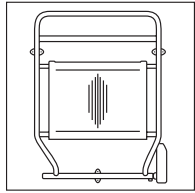

EO 350

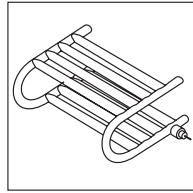

ES40

MODEL	Cat No.	Rated Watts	Width over Flange	Height over Flange	Width c/c Vertical Tubes	c/c Top Flanges to Lower Flange	Overall Width	Overall Projection	Wall to Centre of Connection	Tube Diameter
EO90	260070	90	581	641	508	345	585	101	89	25.4
EO130	260071	130	581	872	508	580	585	101	89	25.4
EO150	260072	150	835	875	762	550	835	101	89	25.4
EO350	260073	350	637	875	565	635	637	114	89	25.4
*ES40/1	264622	90	464	172	432	N/A	527	305	80	31.75
*ES40/2	264623	130	616	172	584	N/A	679	305	80	31.75

ERR300 – See Rotondo range for dimensions.

EMR750 – See MRS range for dimensions.

*Also available in Hydronic version.

Cat No. for Chrome finish.

All dimensions are in mm

SHOWER CURTAIN RAILS

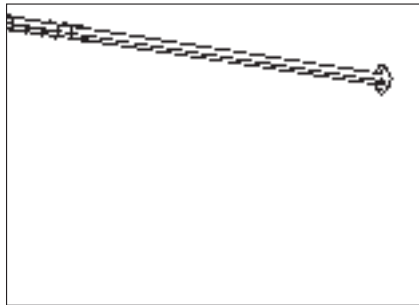

CR1

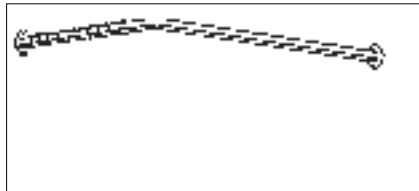

CR2

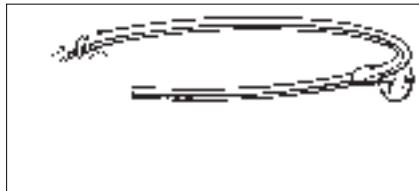

CR3

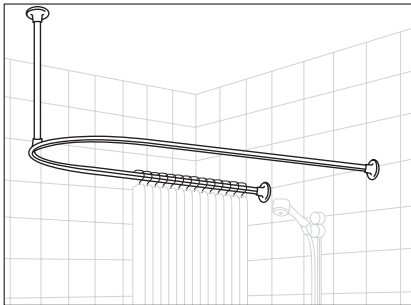

CR4

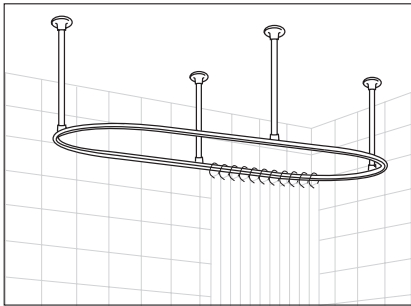

CR5

Model	Size (inches)	Chrome	Regal gold
CR1	48	270015	270016
CR1	60	270018	270019
CR1	72	270003	270004
CR1	84	270007	270008
CR2	30x30	270002	270022
CR2	30x36	270024	270025
CR2	42x24	270000	270028
CR2	36x36	270030	270031
CR3	24 dia	270011	270012
CR3	30 dia	270010	270009
CR4	48x28	270001	270034
CR5	60x28	270037	270038

NOTE: TO CONVERT HEAT OUTPUTS FROM Btu/hr TO WATTS x 0.293