

ALL MEASUREMENTS ARE IN MILLIMETRES | MANUFACTURED FROM MILD STEEL

## 3M8

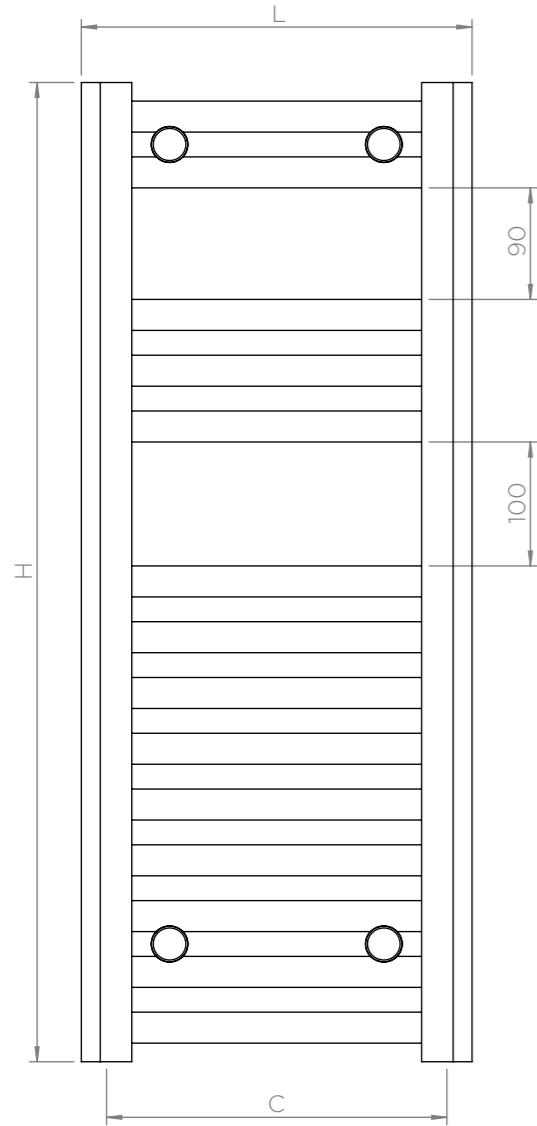

Front View

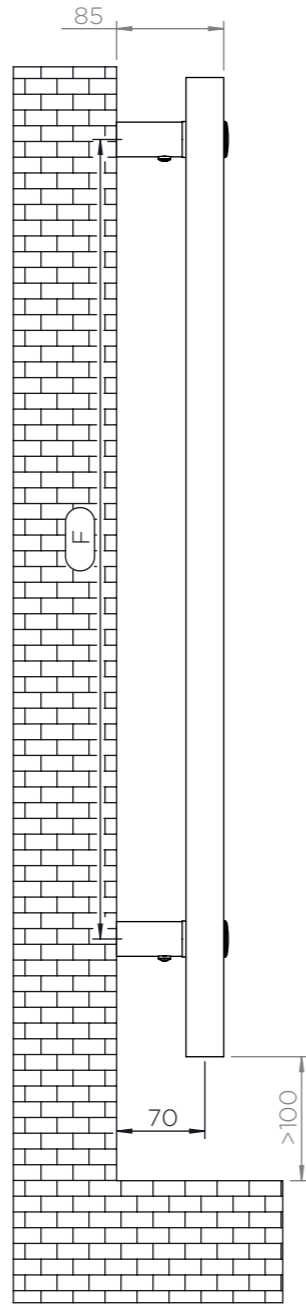

Side View

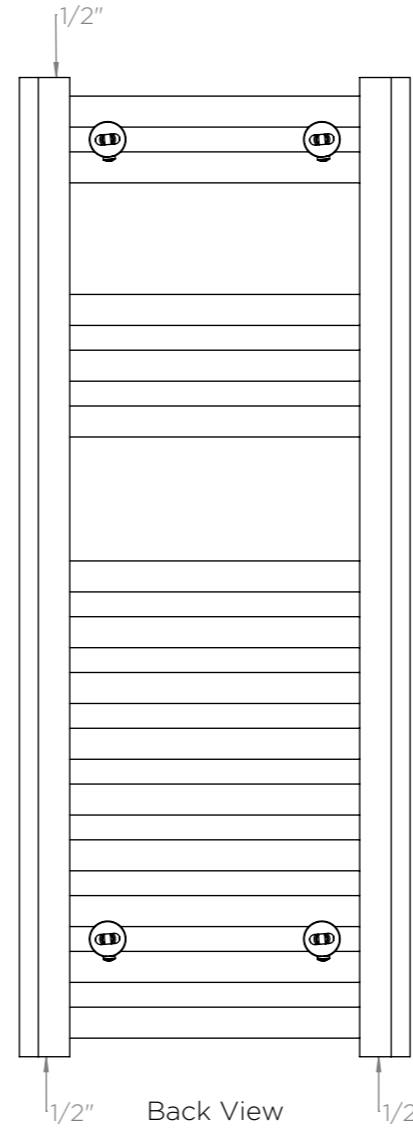

1/2" Back View 1/2"

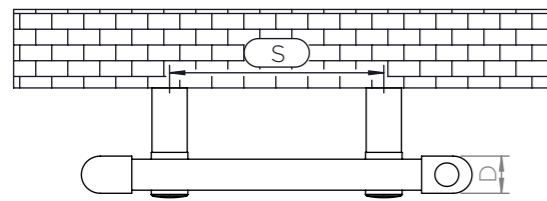
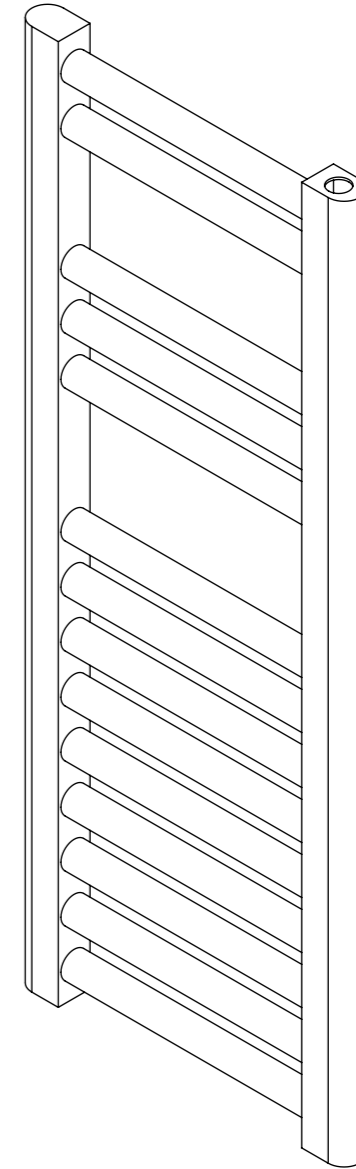

Top View

### Installation Accessories:

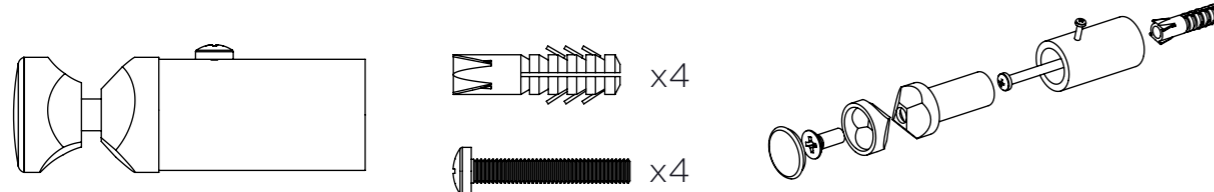

### Plumbing Position: Vertical Mount

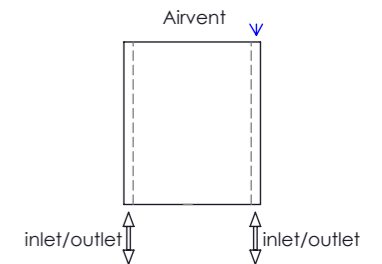

All Dimension are in mm  
 Max.Working Pressure: 10 Bar  
 Max.Working Temperature: 95° C  
 Inlet / Outlet : 1/2" BSP  
 Fuel: E/H/D  
 Ø25x1.2 mm Hor. Tubes  
 30x40x1.5 mm Vert. Profiles

PRODUCT CODE	HEIGHT (H)	LENGTH (L)	DEPTH (D)	PIPE CENTRES (C)	BRACKET CENTRES	
	mm	mm	mm		F	S
3M8	790	310	30	270	645	170

ALL MEASUREMENTS ARE IN MILLIMETRES MANUFACTURED FROM MILD STEEL

## 3M12

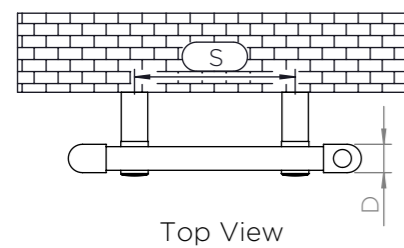
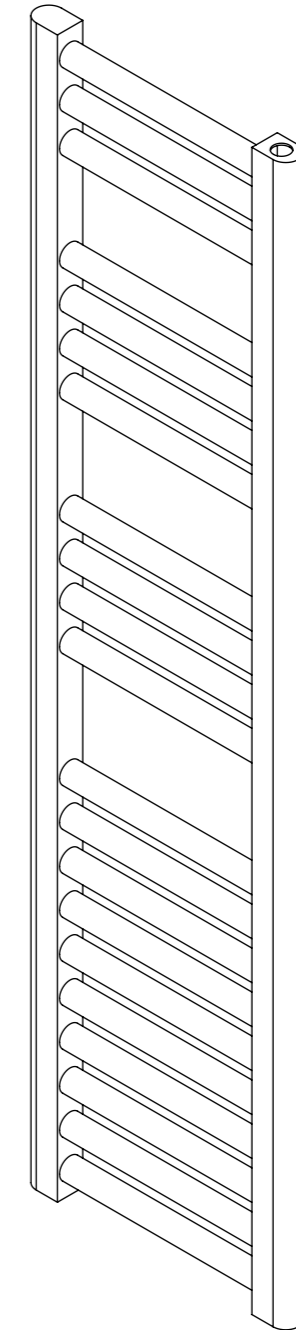
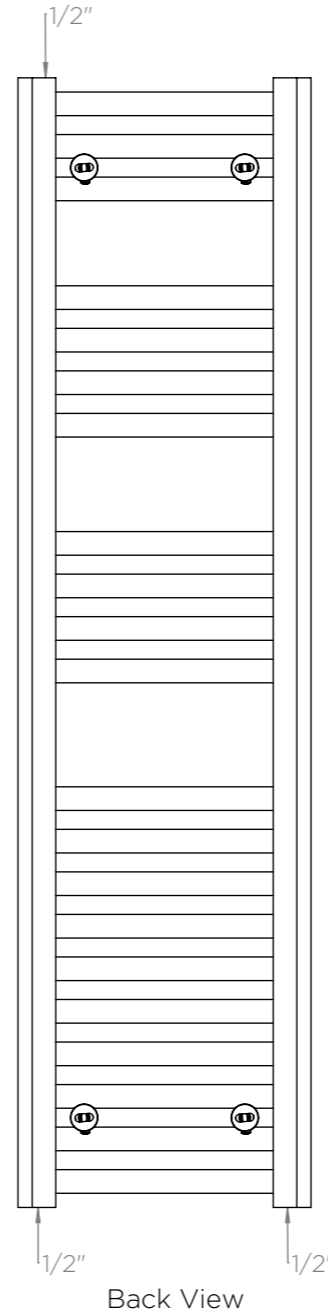
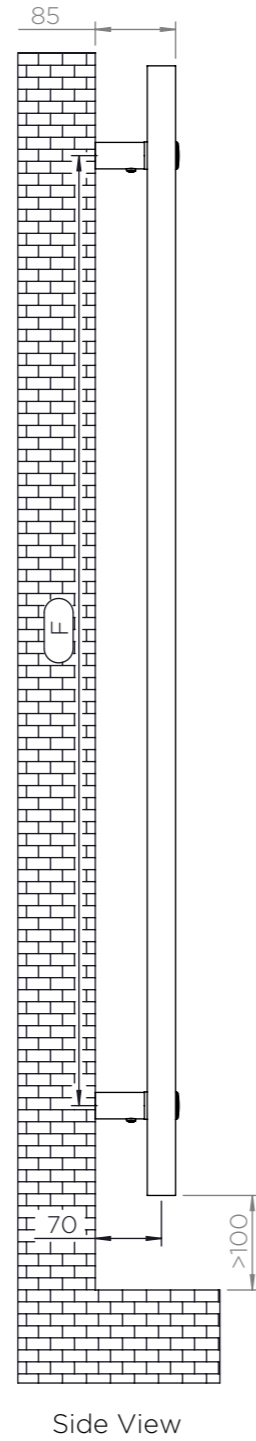
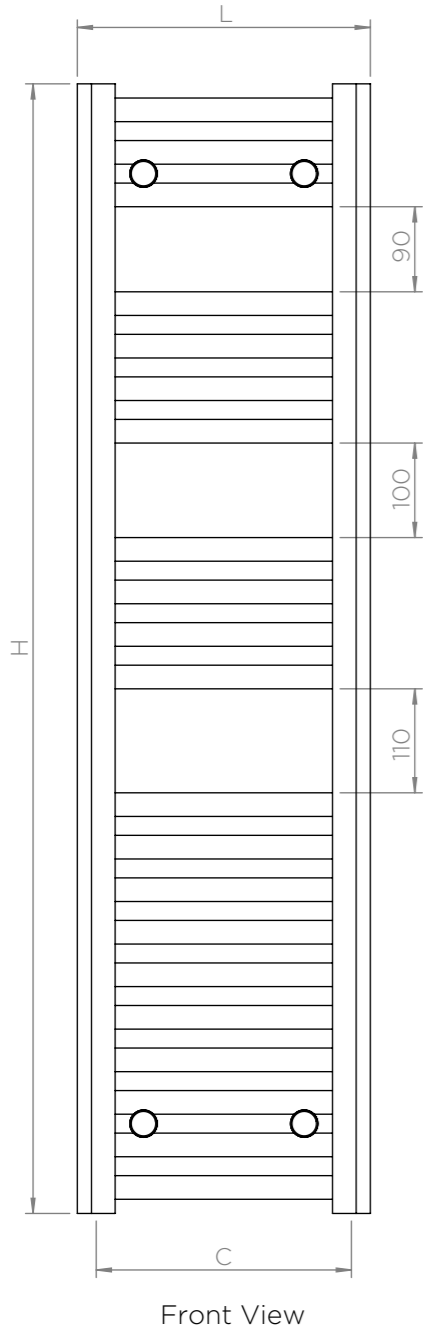

### Installation Accessories:

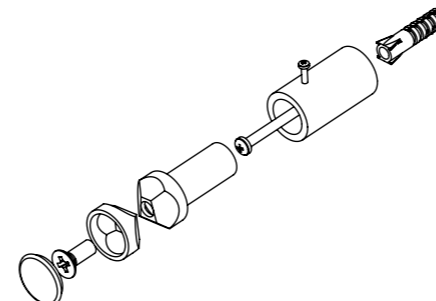
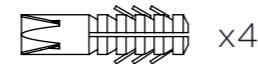
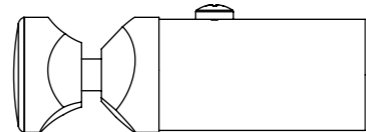

### Plumbing Position: Vertical Mount

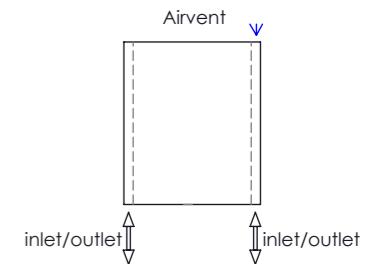

All Dimension are in mm  
 Max.Working Pressure: 10 Bar  
 Max.Working Temperature: 95° C  
 Inlet / Outlet : 1/2" BSP  
 Fuel: E/H/D  
 Ø25x1.2 mm Hor. Tubes  
 30x40x1.5 mm Vert. Profiles

PRODUCT CODE	HEIGHT (H)	LENGTH (L)	DEPTH (D)	PIPE CENTRES (C)	BRACKET CENTRES	
	mm	mm	mm	mm	F mm	S mm
3M12	1195	310	30	270	1005	170

ALL MEASUREMENTS ARE IN MILLIMETRES MANUFACTURED FROM MILD STEEL

## 4M7

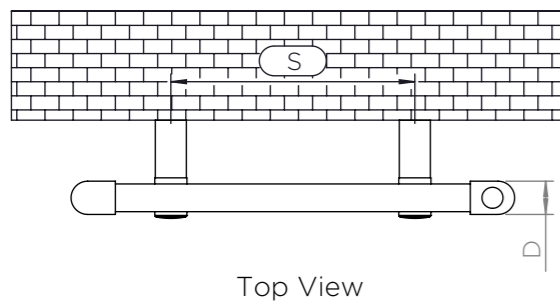
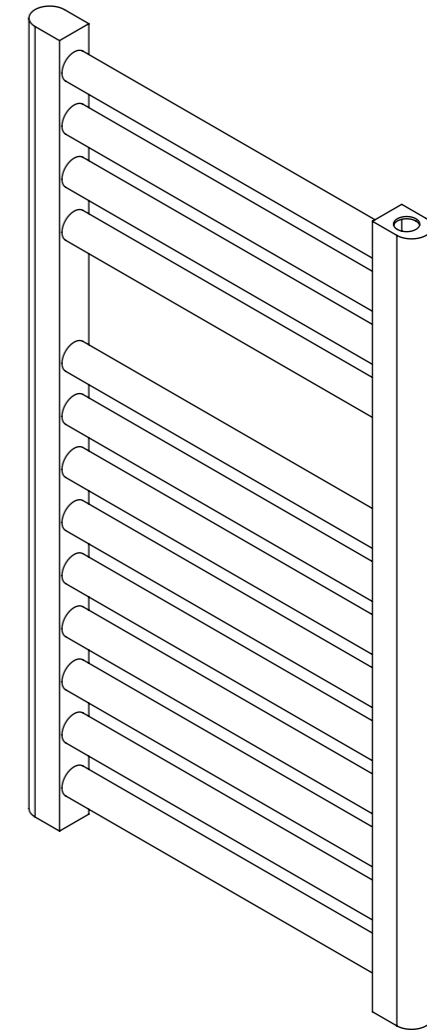
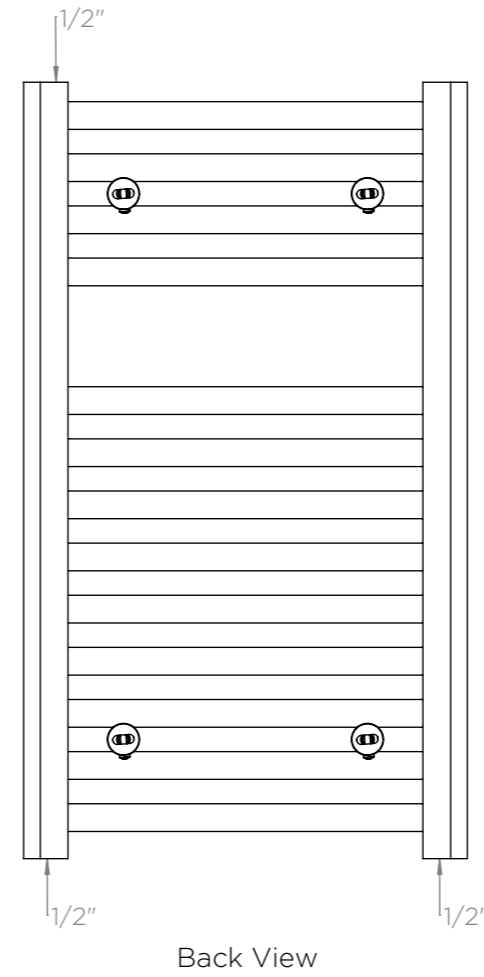
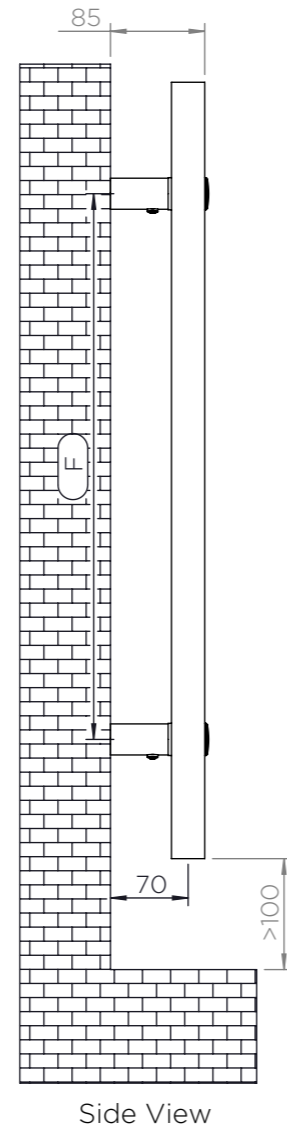
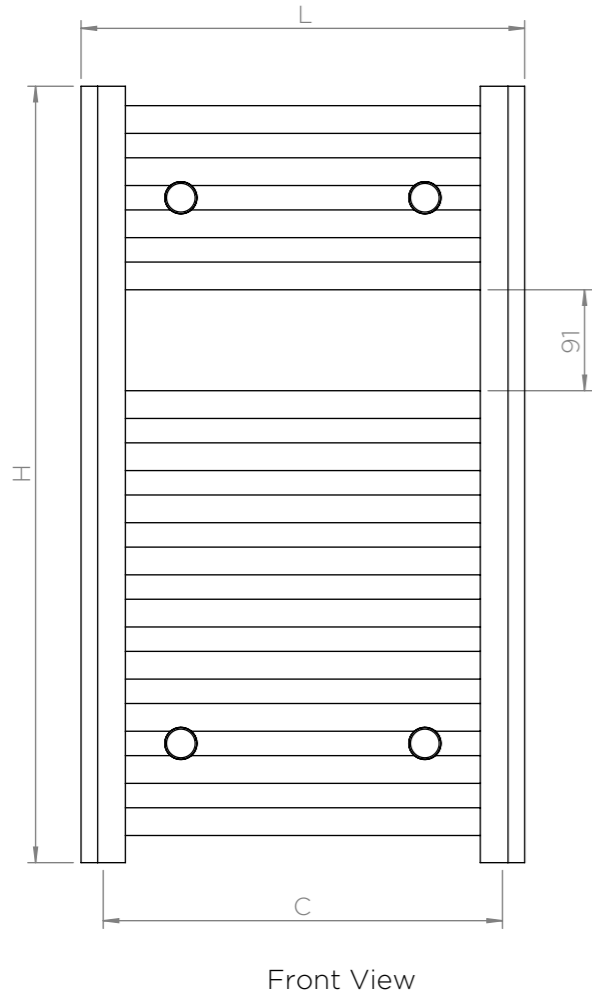

Installation Accessories:

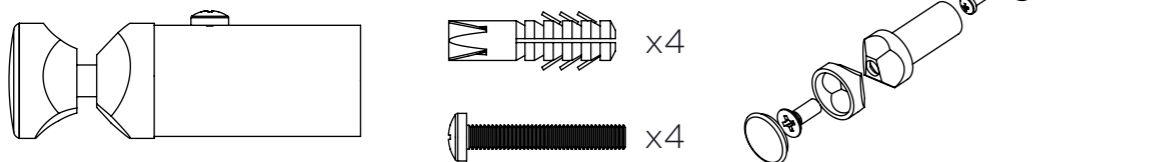

Plumbing Position:  
 Vertical Mount

All Dimension are in mm  
 Max. Working Pressure: 10 Bar  
 Max. Working Temperature: 95° C  
 Inlet / Outlet : 1/2" BSP  
 Fuel: E/H/D  
 Ø25x1.2 mm Hor. Tubes  
 30x40x1.5 mm Vert. Profiles

PRODUCT CODE	HEIGHT (H)	LENGTH (L)	DEPTH (D)	PIPE CENTRES (C)	BRACKET CENTRES	
	mm	mm	mm		F	S
4M7	700	420	30	380	492	220

ALL MEASUREMENTS ARE IN MILLIMETRES | MANUFACTURED FROM MILD STEEL

## 4M9, 5M9, 6M9

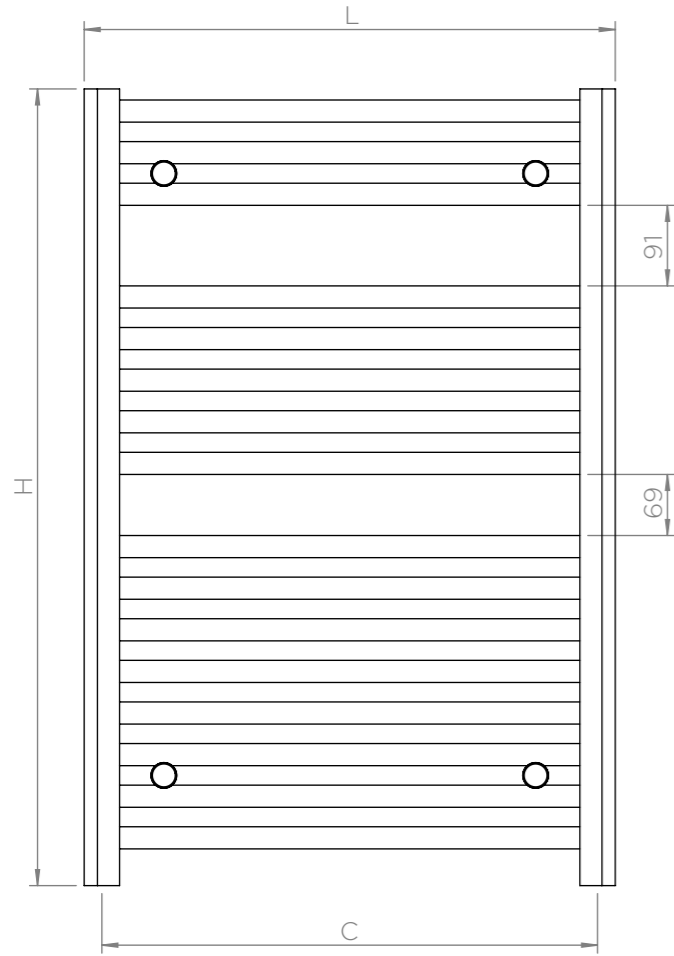

Front View

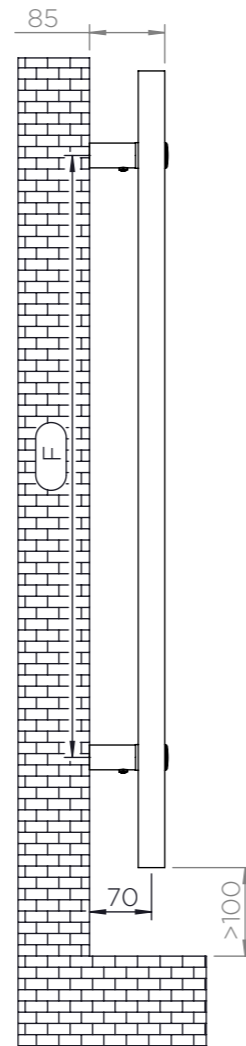

Side View

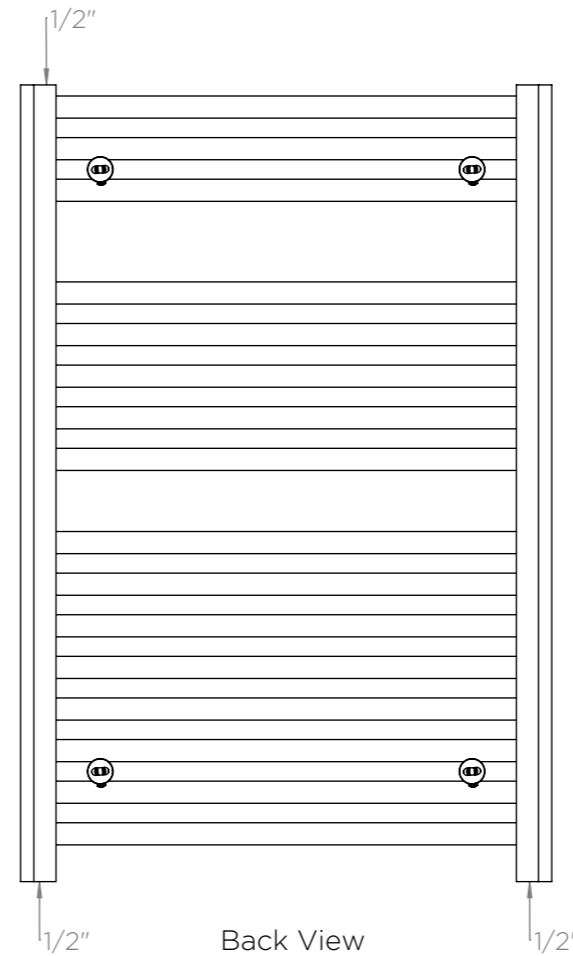

Back View

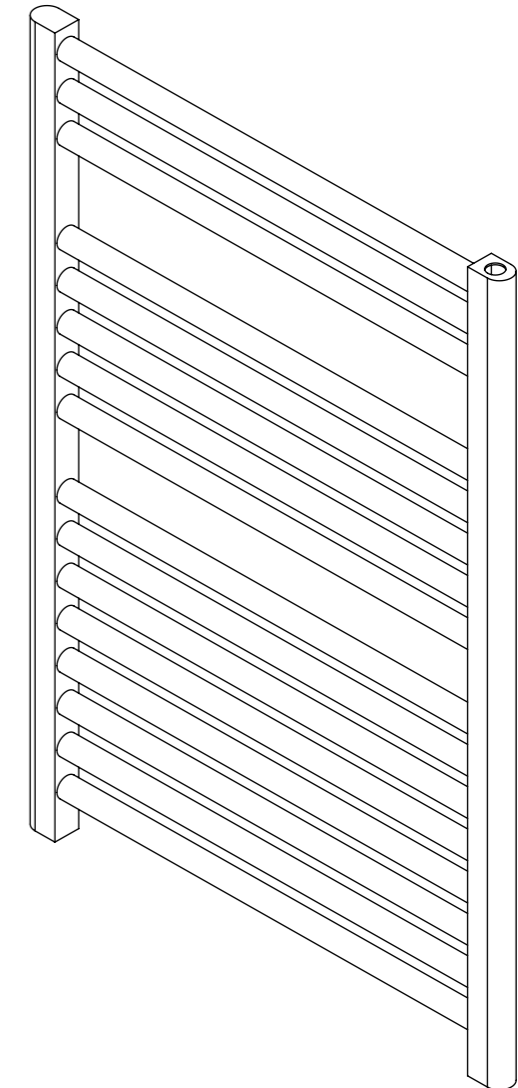

Top View

Plumbing Position:  
Vertical Mount

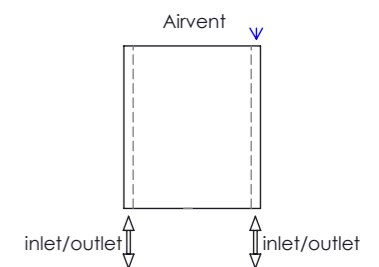

All Dimension are in mm  
 Max.Working Pressure: 10 Bar  
 Max.Working Temperature: 95° C  
 Inlet / Outlet : 1/2" BSP  
 Fuel: E/H/D  
 Ø25x1.2 mm Hor. Tubes  
 30x40x1.5 mm Vert. Profiles

### Installation Accessories:

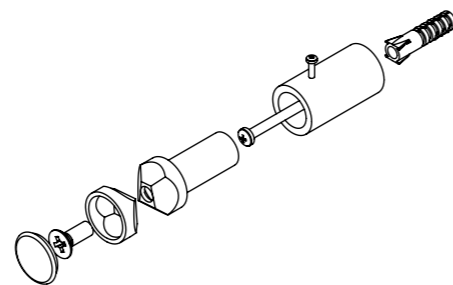
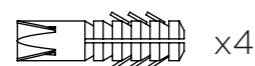
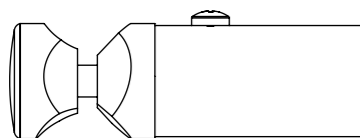

PRODUCT CODE	HEIGHT (H)	LENGTH (L)	DEPTH (D)	PIPE CENTRES (C)	BRACKET CENTRES	
	mm	mm	mm		F	S
4M9	900	420	30	380	680	240
5M9	900	500	30	460	680	320
6M9	900	600	30	560	680	420

ALL MEASUREMENTS ARE IN MILLIMETRES MANUFACTURED FROM MILD STEEL

## 4M12

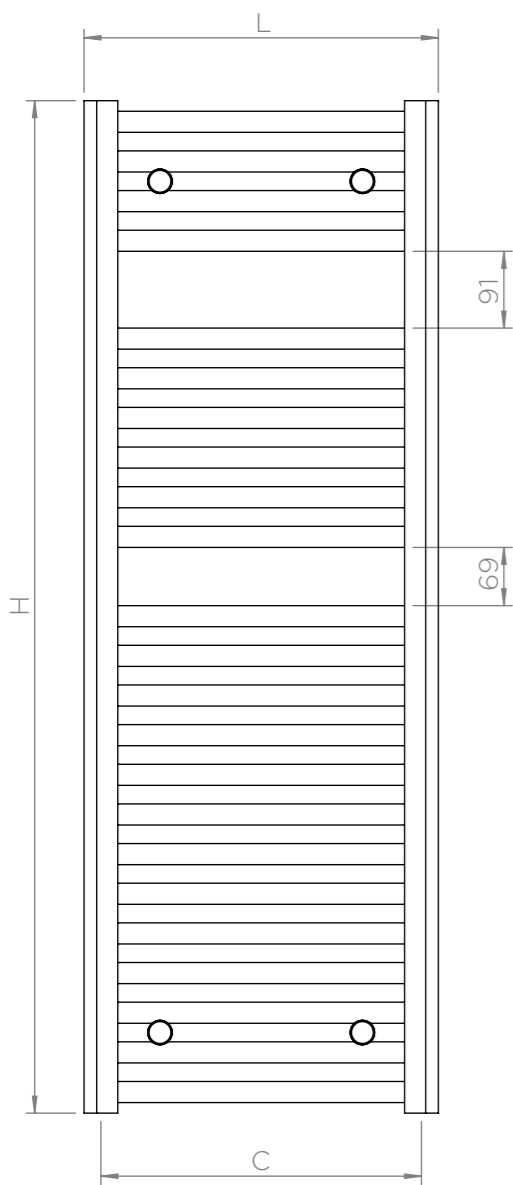

Front View

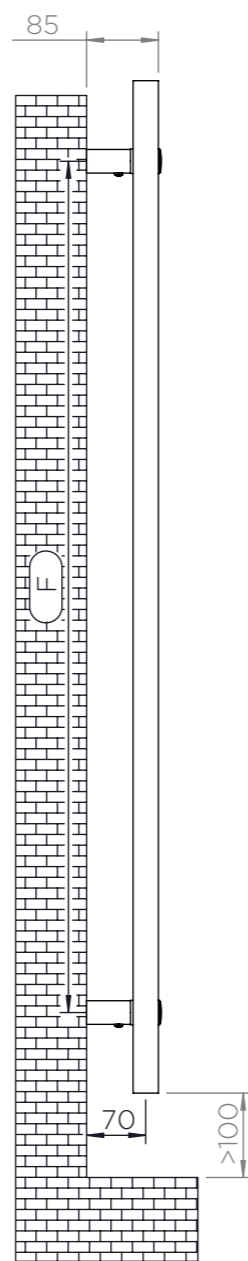

Side View

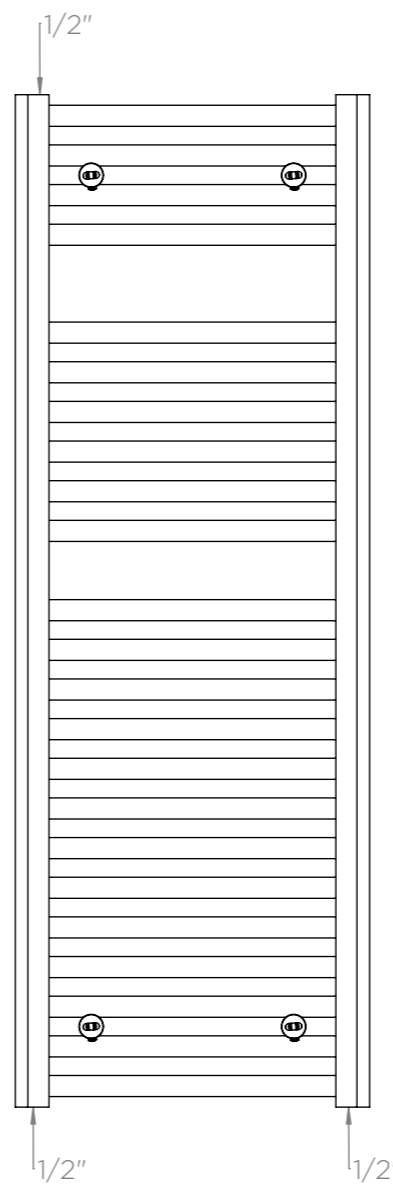

Back View

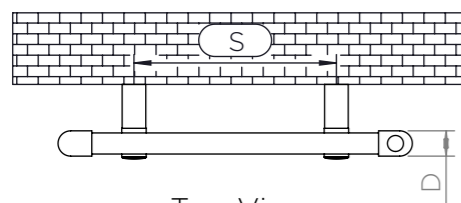
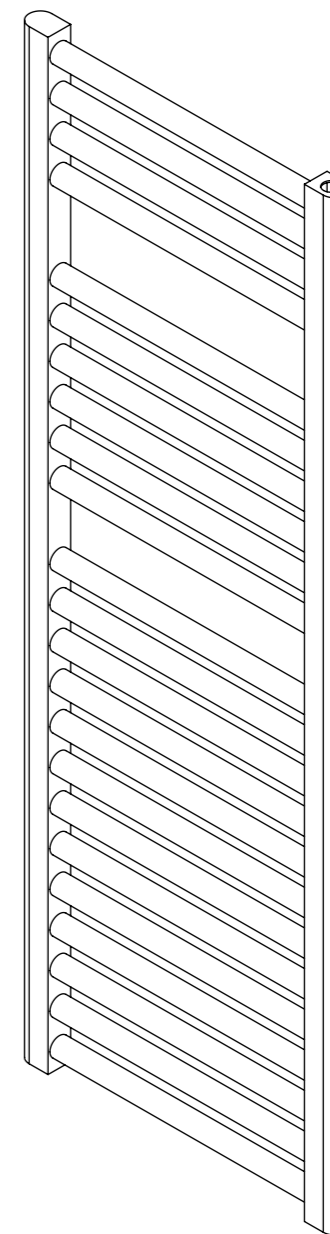

Top View

### Installation Accessories:

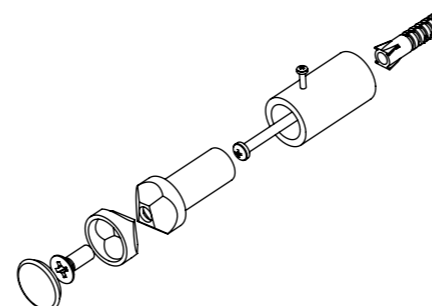
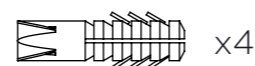
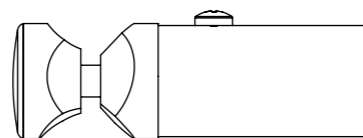

### Plumbing Position: Vertical Mount

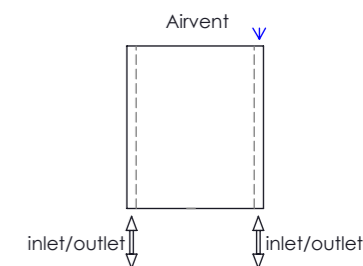

All Dimension are in mm  
 Max.Working Pressure: 10 Bar  
 Max.Working Temperature: 95° C  
 Inlet / Outlet : 1/2" BSP  
 Fuel: E/H/D  
 Ø25x1.2 mm Hor. Tubes  
 30x40x1.5 mm Vert. Profiles

PRODUCT CODE	HEIGHT (H)	LENGTH (L)	DEPTH (D)	PIPE CENTRES (C)	BRACKET CENTRES	
	mm	mm	mm		F mm	S mm
4M12	1200	420	30	380	1009	240

ALL MEASUREMENTS ARE IN MILLIMETRES | MANUFACTURED FROM MILD STEEL

## 4M15, 5M15, 6M15

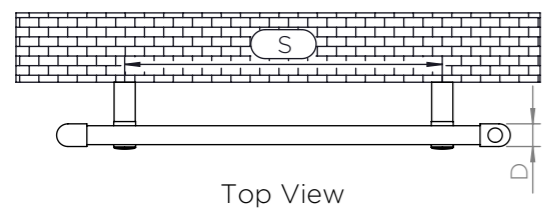
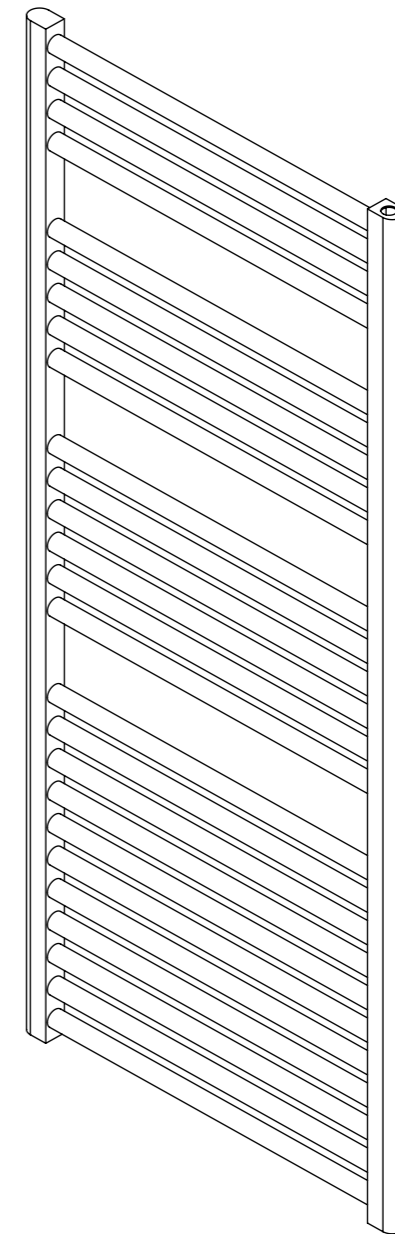
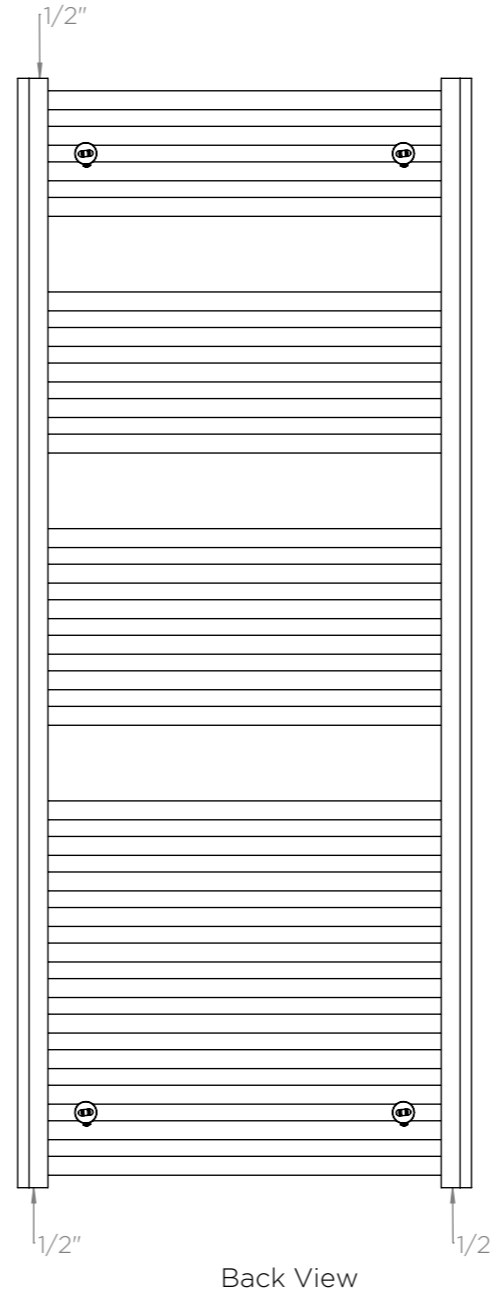
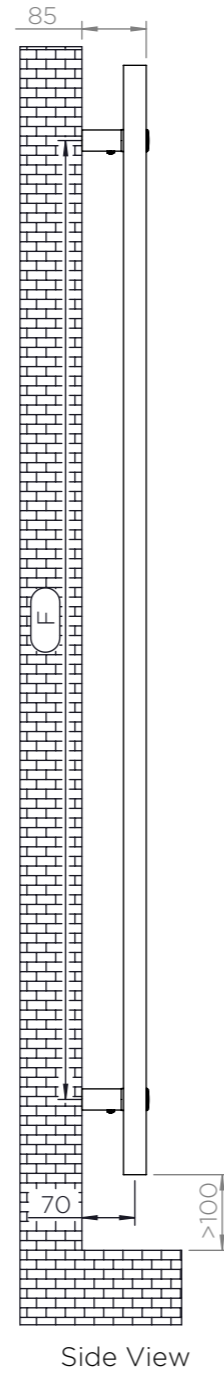
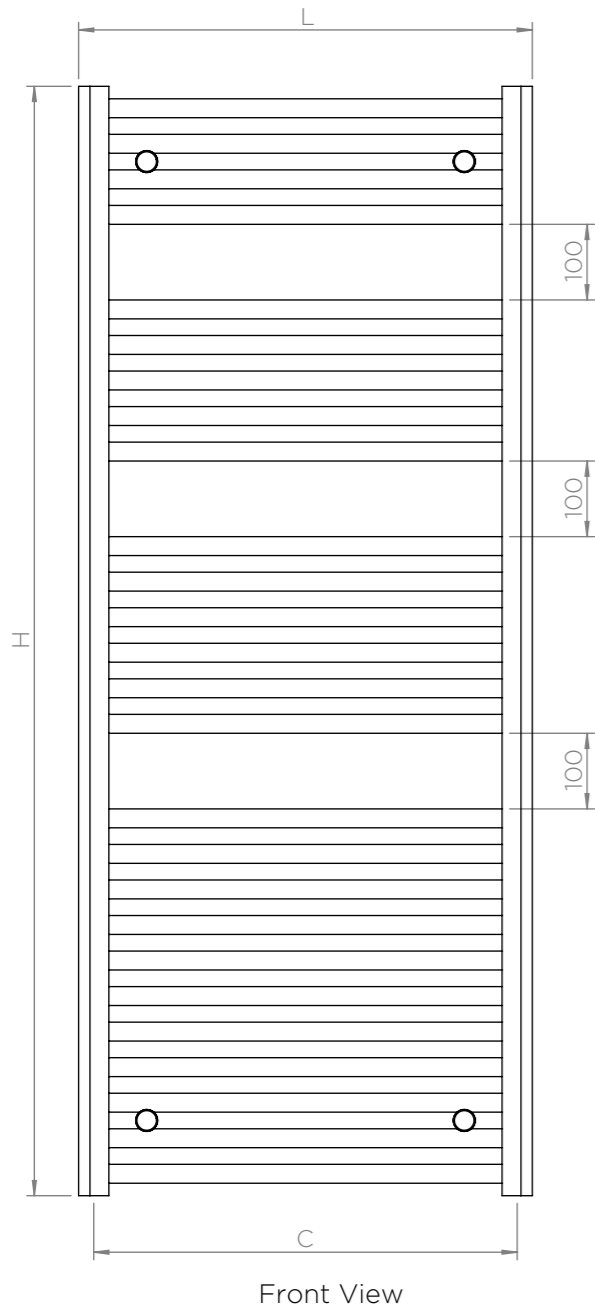

### Installation Accessories:

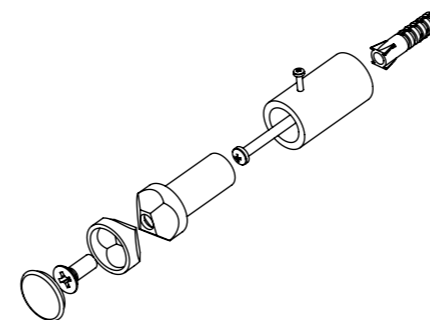
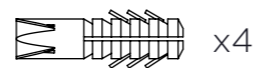
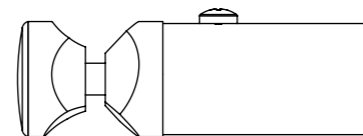

### Plumbing Position: Vertical Mount

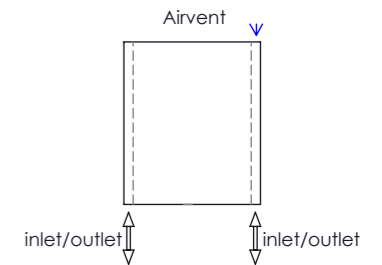

All Dimension are in mm  
 Max.Working Pressure: 10 Bar  
 Max.Working Temperature: 95° C  
 Inlet / Outlet : 1/2" BSP  
 Fuel: E/H/D  
 Ø25x1.2 mm Hor. Tubes  
 30x40x1.5 mm Vert. Profiles

PRODUCT CODE	HEIGHT (H) mm	LENGTH (L) mm	DEPTH (D) mm	PIPE CENTRES (C) mm	BRACKET CENTRES	
					F mm	S mm
4M15	1467	420	30	380	1268	240
5M15	1467	500	30	460	1268	320
6M15	1467	600	30	560	1268	420

ALL MEASUREMENTS ARE IN MILLIMETRES | MANUFACTURED FROM MILD STEEL

## 5M7, 6M7, 7M7

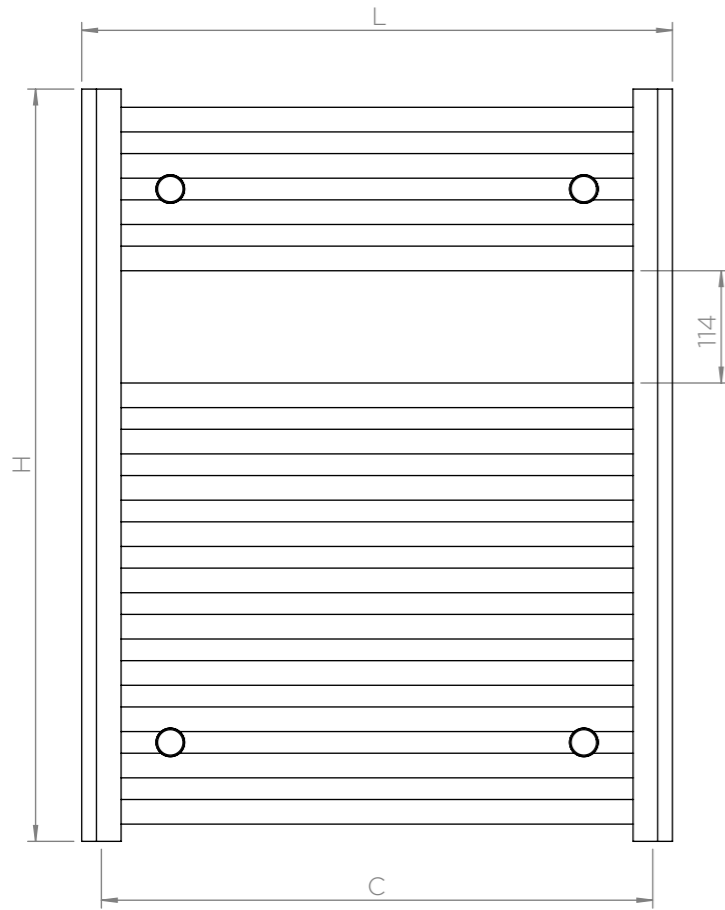

Front View

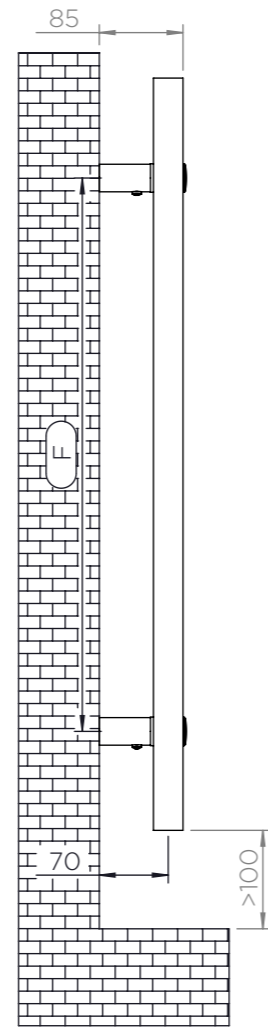

Side View

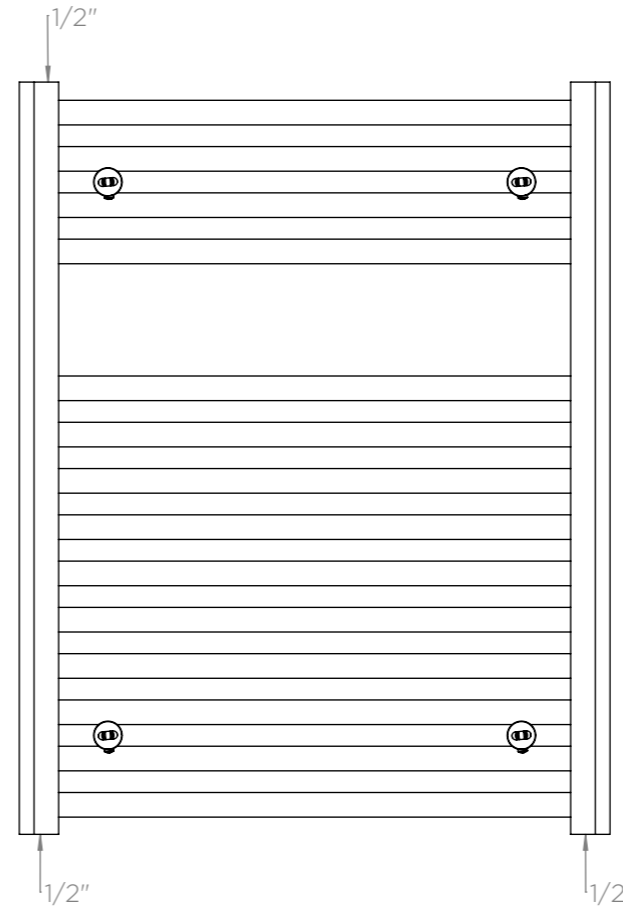

Back View

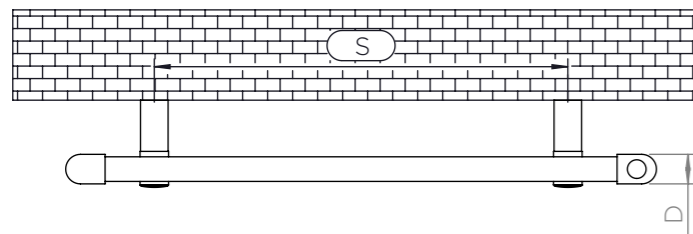
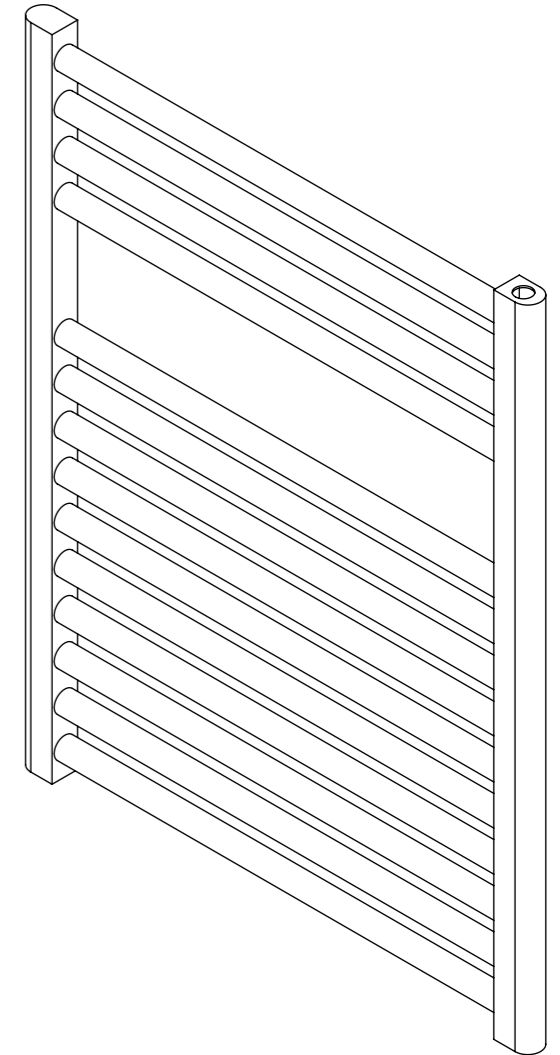

Top View

Plumbing Position:  
Vertical Mount

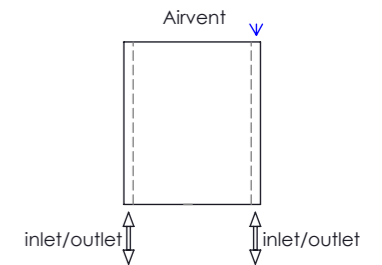

All Dimension are in mm  
 Max.Working Pressure: 10 Bar  
 Max.Working Temperature: 95° C  
 Inlet / Outlet : 1/2" BSP  
 Fuel: E/H/D  
 Ø25x1.2 mm Hor. Tubes  
 30x40x1.5 mm Vert. Profiles

### Installation Accessories:

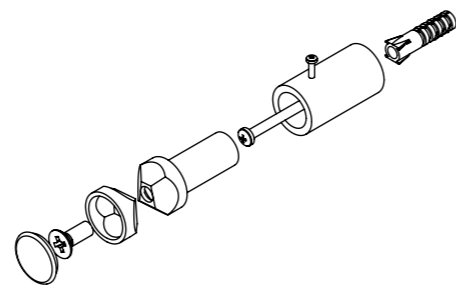
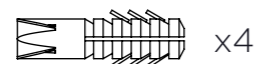
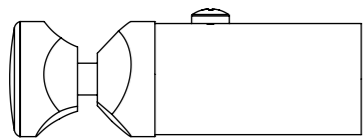

PRODUCT CODE	HEIGHT (H)	LENGTH (L)	DEPTH (D)	PIPE CENTRES (C)	BRACKET CENTRES	
	mm	mm	mm		F	S
5M7	764	500	30	460	562	320
6M7	764	600	30	560	562	420
7M7	764	750	30	710	562	570

ALL MEASUREMENTS ARE IN MILLIMETRES | MANUFACTURED FROM MILD STEEL

## 5M11, 6M11, 7M11

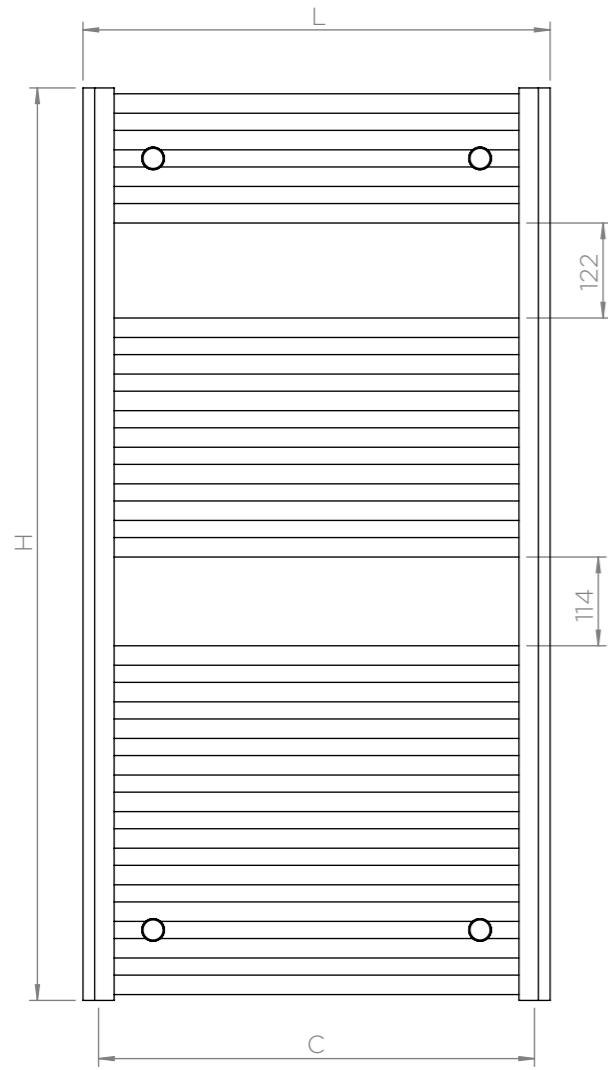

Front View

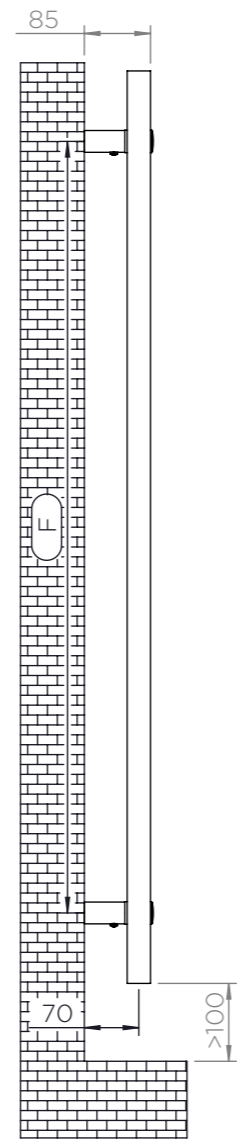

Side View

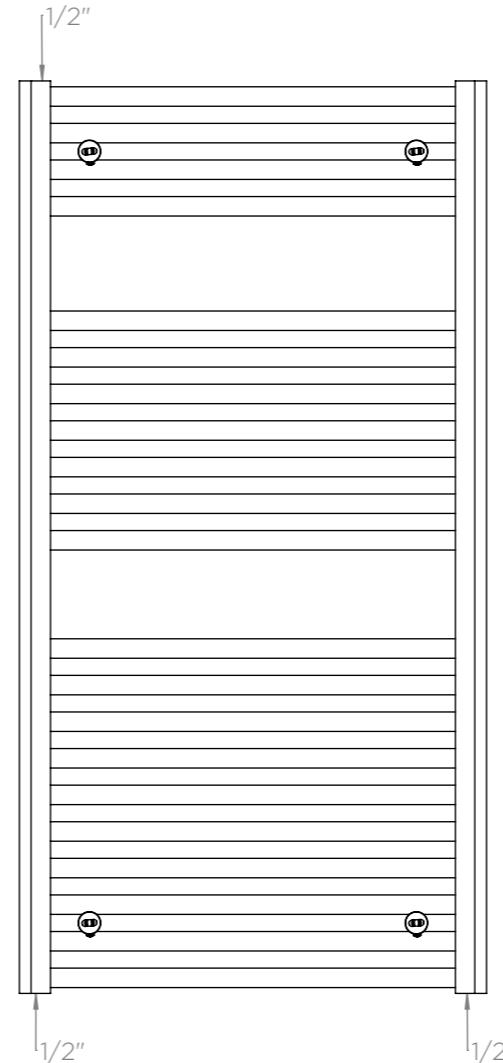

Back View

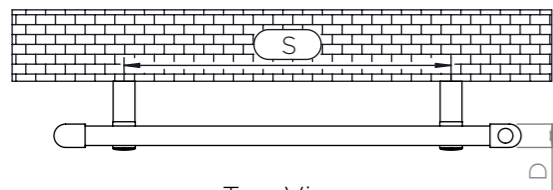
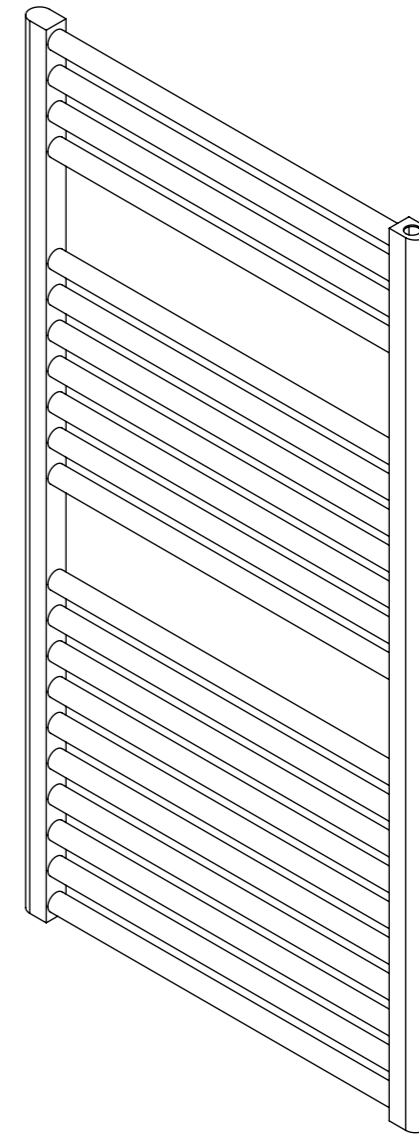

Top View

Plumbing Position:  
Vertical Mount

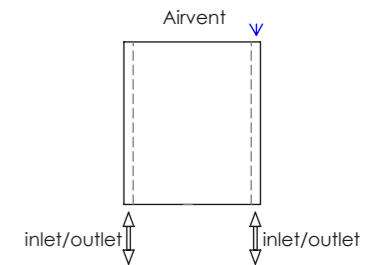

All Dimension are in mm  
 Max.Working Pressure: 10 Bar  
 Max.Working Temperature: 95° C  
 Inlet / Outlet : 1/2" BSP  
 Fuel: E/H/D  
 Ø25x1.2 mm Hor. Tubes  
 30x40x1.5 mm Vert. Profiles

### Installation Accessories:

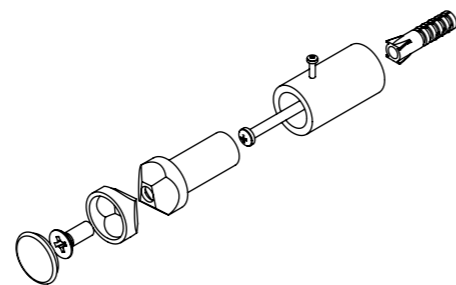
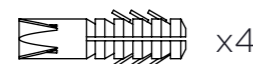
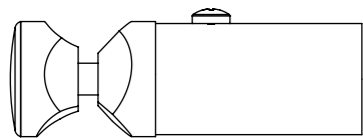

PRODUCT CODE	HEIGHT (H)	LENGTH (L)	DEPTH (D)	PIPE CENTRES (C)	BRACKET CENTRES	
	mm	mm	mm		F	S
5M11	1172	500	30	460	991	320
6M11	1172	600	30	560	991	420
7M11	1172	750	30	710	991	570