

TROGON - TR0550

INS-VS1

ALL MEASUREMENTS ARE IN MILLIMETRES

MANUFACTURED FROM STAINLESS STEEL

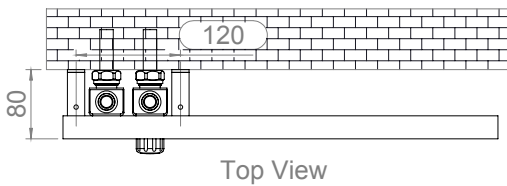
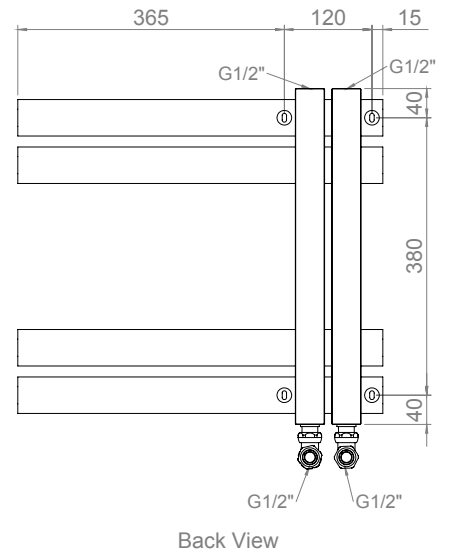
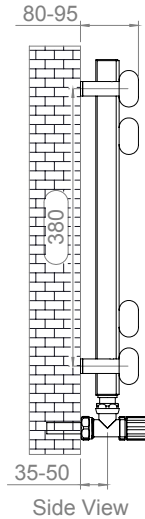
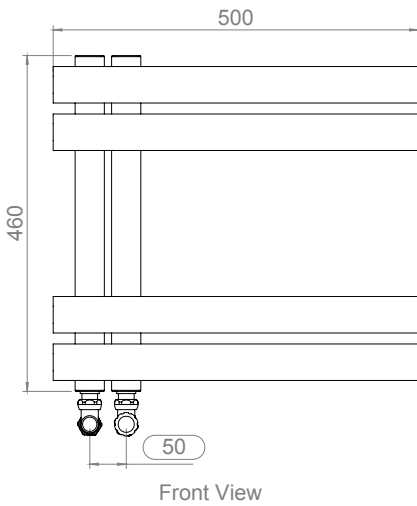
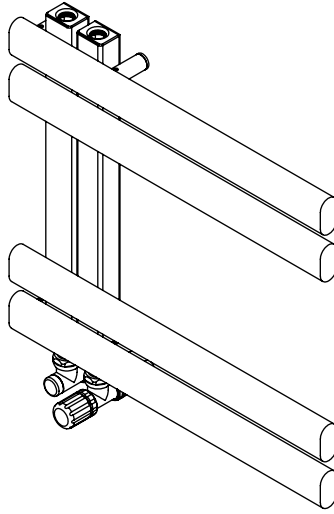

INSTALLATION ACCESSORIES:

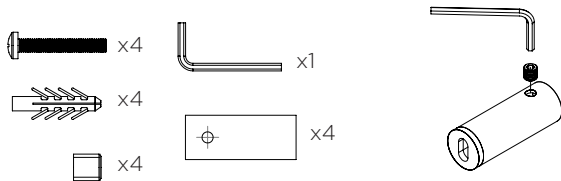

AIRVENT

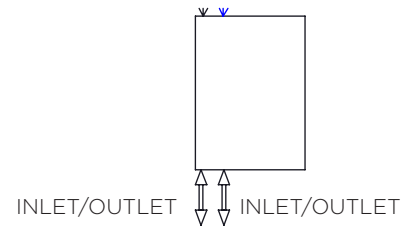

Vertical Mount

All Dimension are in mm
 Max.Working Pressure = 10 Bar
 Max.Working Temperature=95° C
 Inlet / Outlet : 1/2" BSP
 Fuel: H

Technical specifications are subject to change without prior notice.

AEON is the designer heating division of Pitacs Limited.
 Pitacs Limited, Bradbourne Point, Bradbourne Drive, Tilbrook, Milton Keynes,
 Buckinghamshire, MK7 8AT, UK

T: +44 (0)1908 271155 E: info@pitacs.com W: www.aeon.uk.com



TROGON - TR0850

INS-VS1

ALL MEASUREMENTS ARE IN MILLIMETRES

MANUFACTURED FROM STAINLESS STEEL

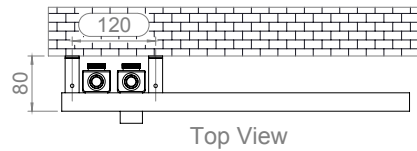
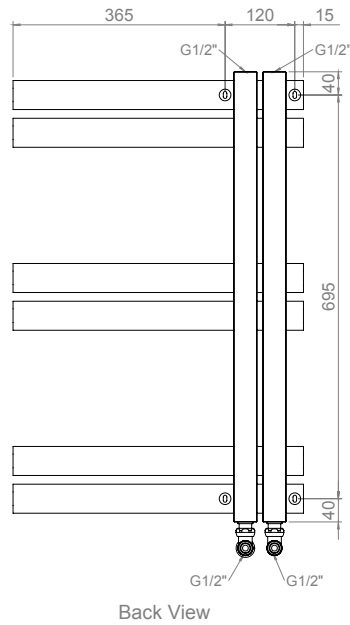
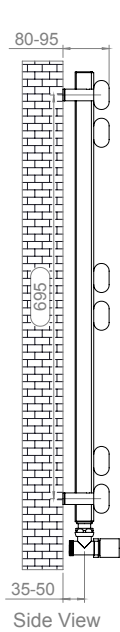
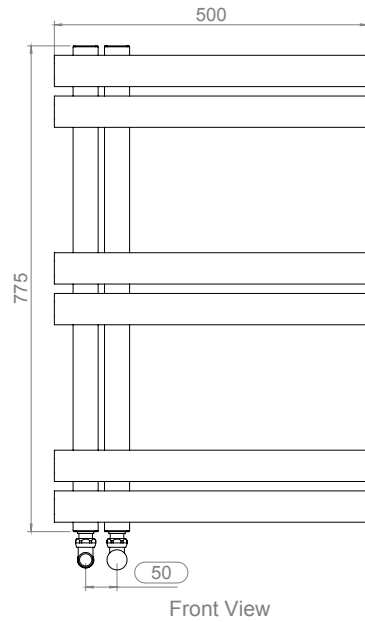
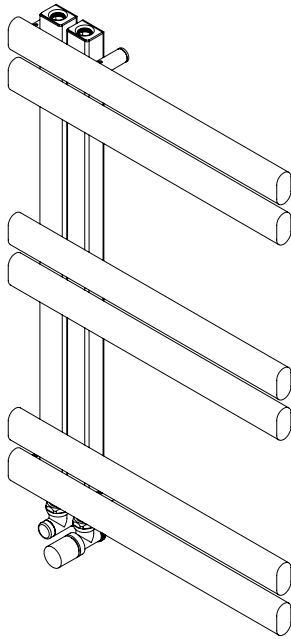

AIRVENT

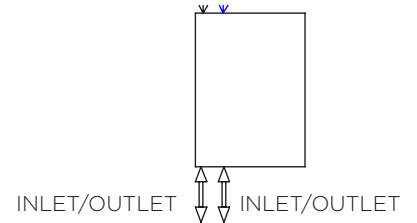

INSTALLATION ACCESSORIES:

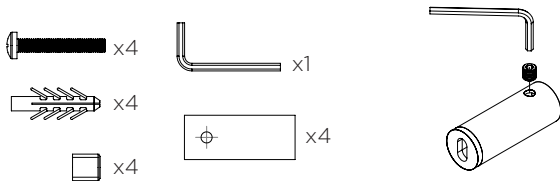

Vertical Mount

All Dimension are in mm

Max.Working Pressure = 10 Bar

Max.Working Temperature=95° C

Inlet / Outlet : 1/2" BSP

Fuel: H

Technical specifications are subject to change without prior notice.

AEON is the designer heating division of Pitacs Limited.
Pitacs Limited, Bradbourne Point, Bradbourne Drive, Tilbrook, Milton Keynes,
Buckinghamshire, MK7 8AT, UK

T: +44 (0)1908 271155 E: info@pitacs.com W: www.aeon.uk.com



TROGON - TR1050

INS-VS1

ALL MEASUREMENTS ARE IN MILLIMETRES

MANUFACTURED FROM STAINLESS STEEL

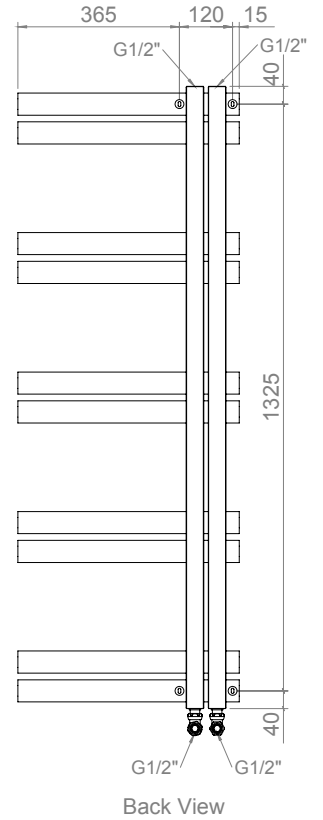
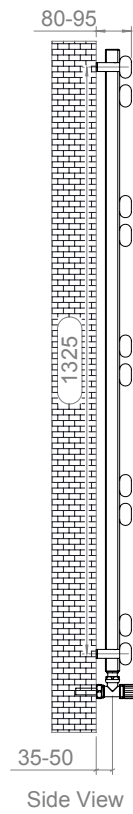
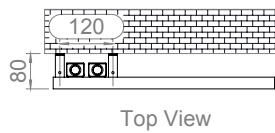
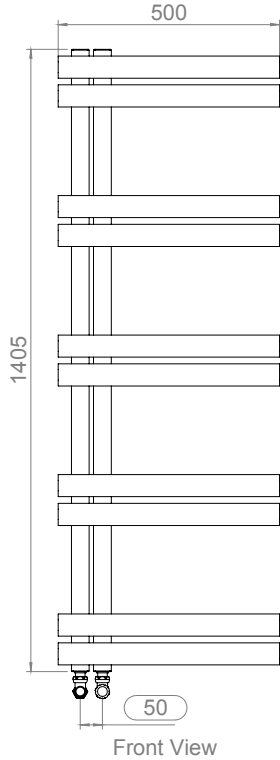
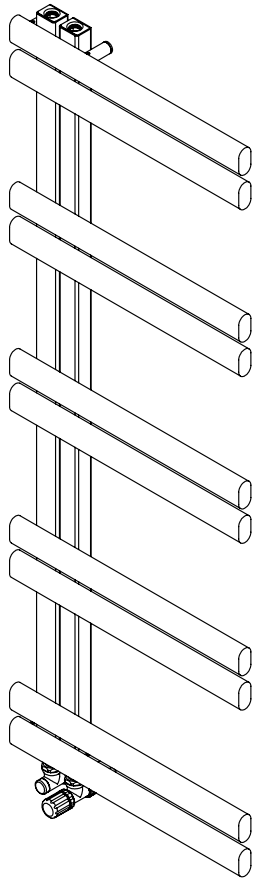

INSTALLATION ACCESSORIES:

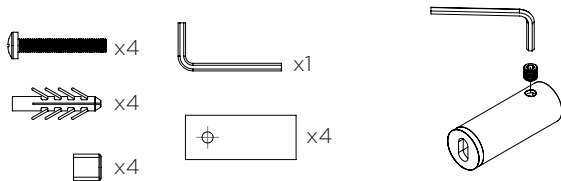

AIRVENT

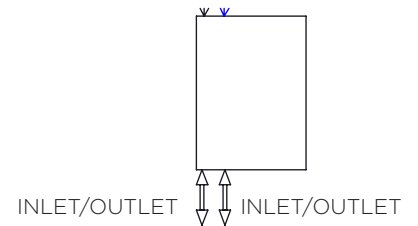

Vertical Mount

All Dimension are in mm

Max.Working Pressure = 10 Bar

Max.Working Temperature=95° C

Inlet / Outlet : 1/2" BSP

Fuel: H

Technical specifications are subject to change without prior notice.

AEON is the designer heating division of Pitacs Limited.
Pitacs Limited, Bradbourne Point, Bradbourne Drive, Tilbrook, Milton Keynes,
Buckinghamshire, MK7 8AT, UK

T: +44 (0)1908 271155 E: info@pitacs.com W: www.aeon.uk.com



TROGON - TR1450

INS-VS1

ALL MEASUREMENTS ARE IN MILLIMETRES

MANUFACTURED FROM STAINLESS STEEL

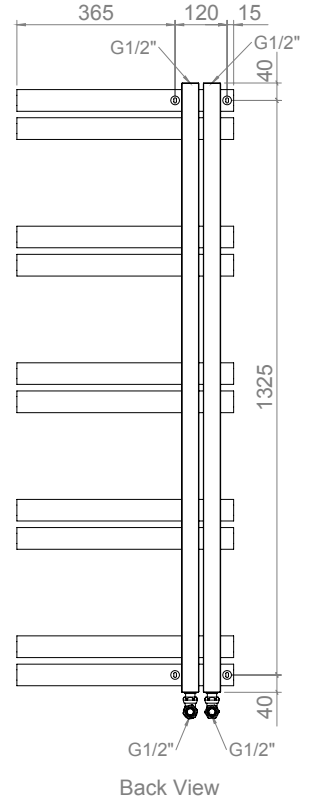
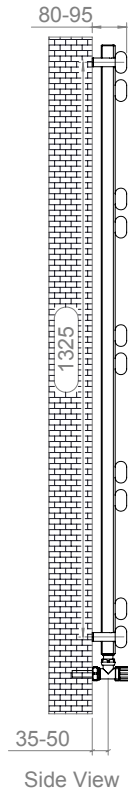
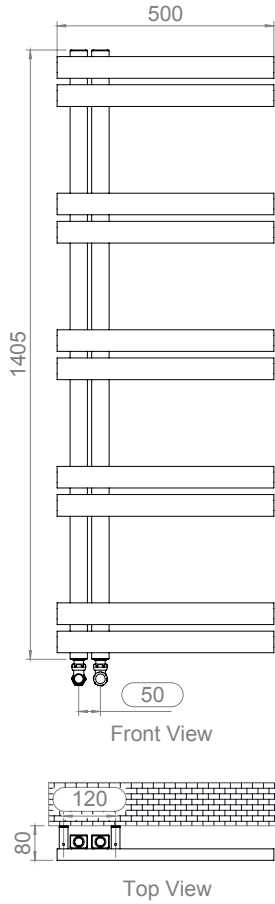
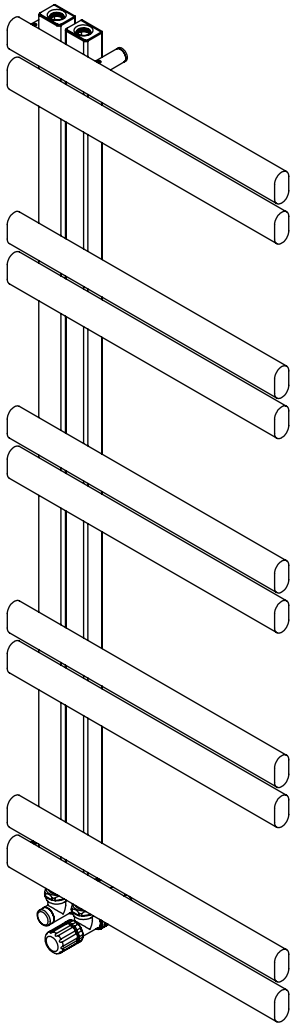

INSTALLATION ACCESSORIES:

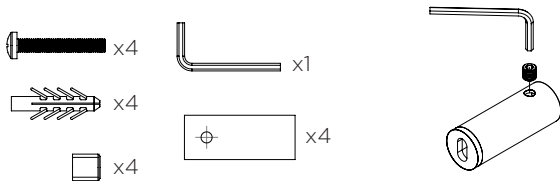

AIRVENT

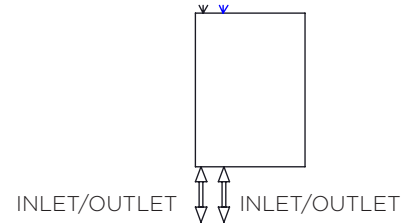

Vertical Mount

All Dimension are in mm

Max.Working Pressure = 10 Bar

Max.Working Temperature=95° C

Inlet / Outlet : 1/2" BSP

Fuel: H

Technical specifications are subject to change without prior notice.

AEON is the designer heating division of Pitacs Limited.
Pitacs Limited, Bradbourne Point, Bradbourne Drive, Tilbrook, Milton Keynes,
Buckinghamshire, MK7 8AT, UK

T: +44 (0)1908 271155 E: info@pitacs.com W: www.aeon.uk.com



TROGON - TR1750

INS-VS1

ALL MEASUREMENTS ARE IN MILLIMETRES

MANUFACTURED FROM STAINLESS STEEL

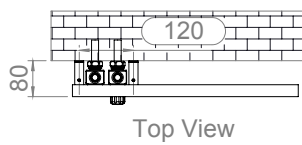
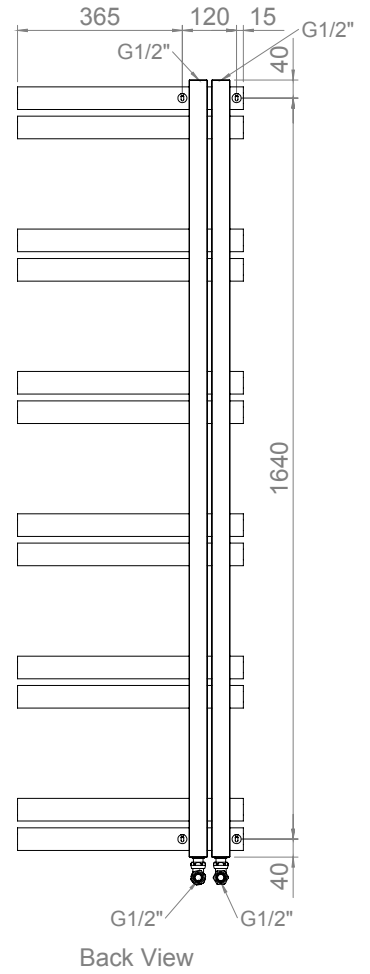
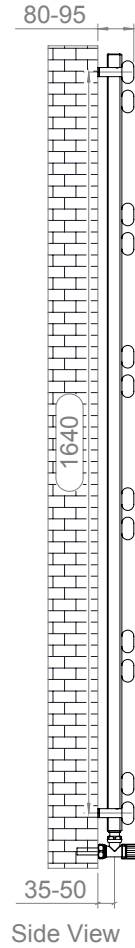
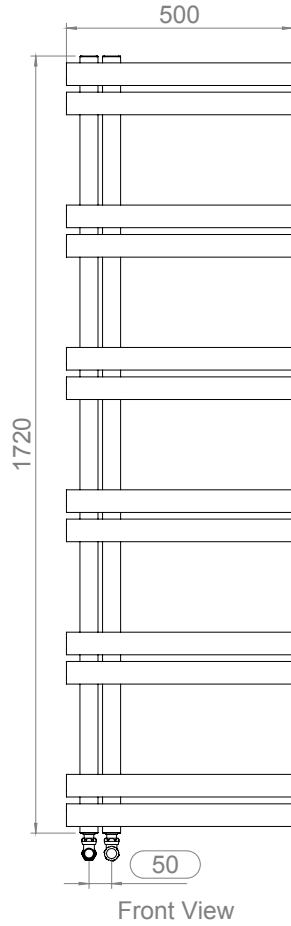
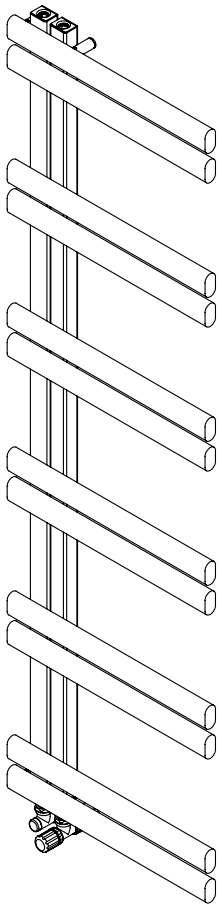

INSTALLATION ACCESSORIES:

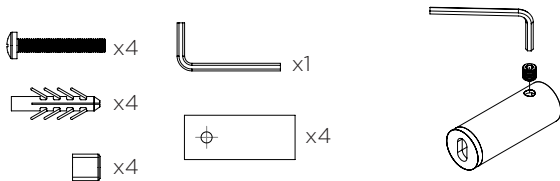

AIRVENT

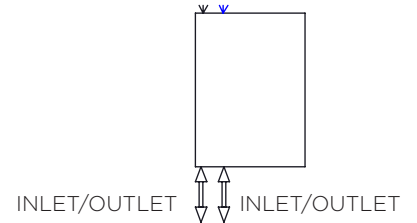

Vertical Mount

All Dimension are in mm

Max.Working Pressure = 10 Bar

Max.Working Temperature=95° C

Inlet / Outlet : 1/2" BSP

Fuel: H

Technical specifications are subject to change without prior notice.

AEON is the designer heating division of Pitacs Limited.
Pitacs Limited, Bradbourne Point, Bradbourne Drive, Tilbrook, Milton Keynes,
Buckinghamshire, MK7 8AT, UK

T: +44 (0)1908 271155 E: info@pitacs.com W: www.aeon.uk.com