

ALL MEASUREMENTS ARE IN MILLIMETRES MANUFACTURED FROM MILD STEEL

3K10

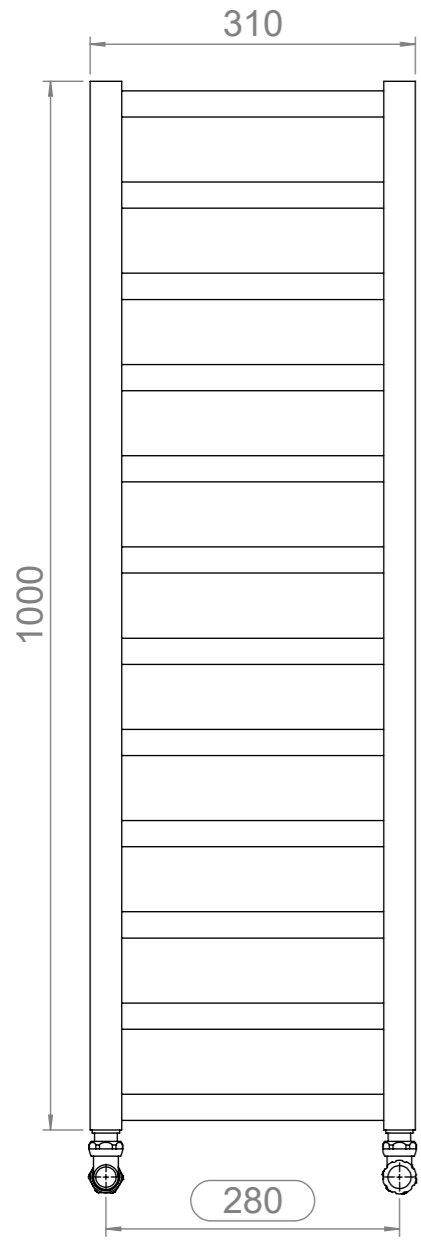

Front View

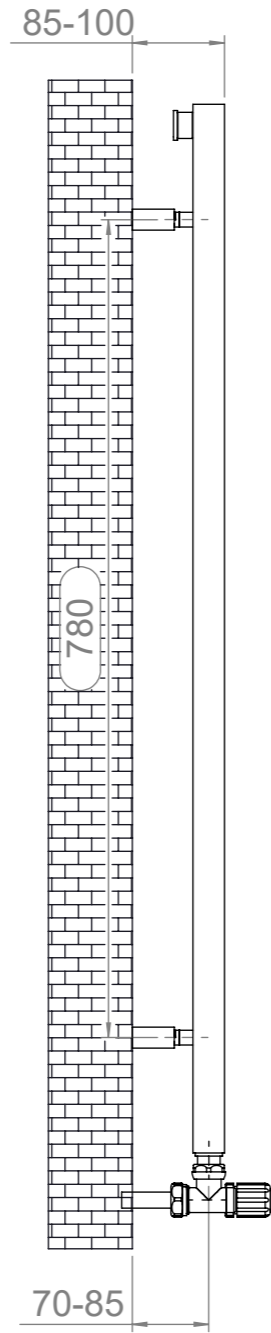

Side View

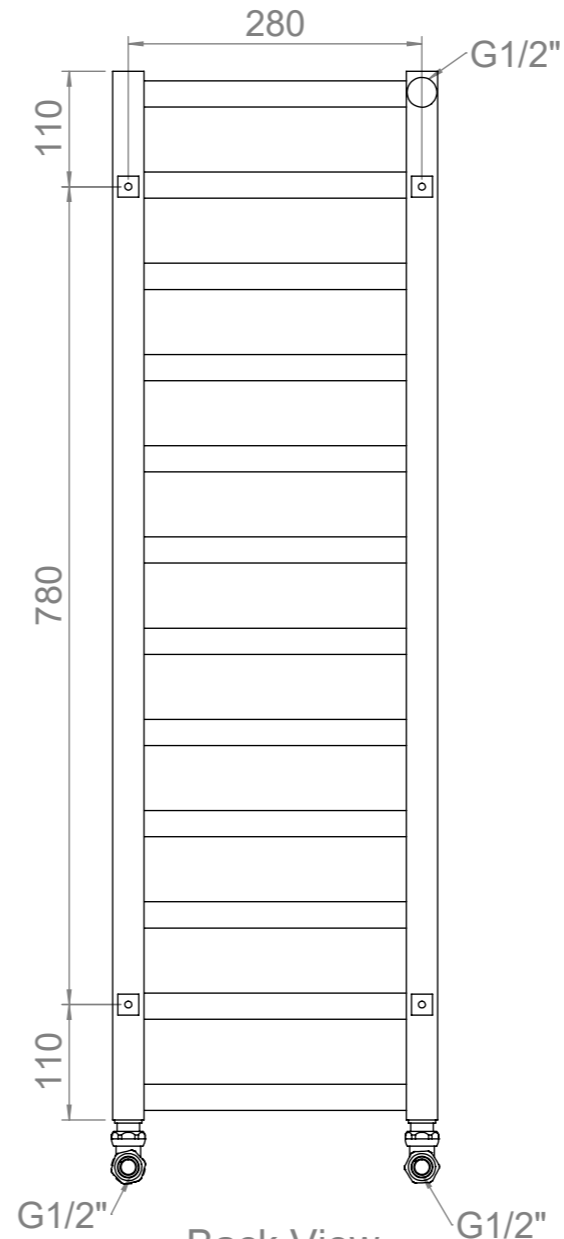



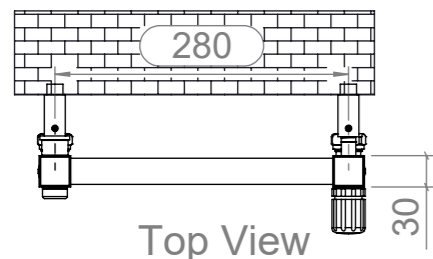
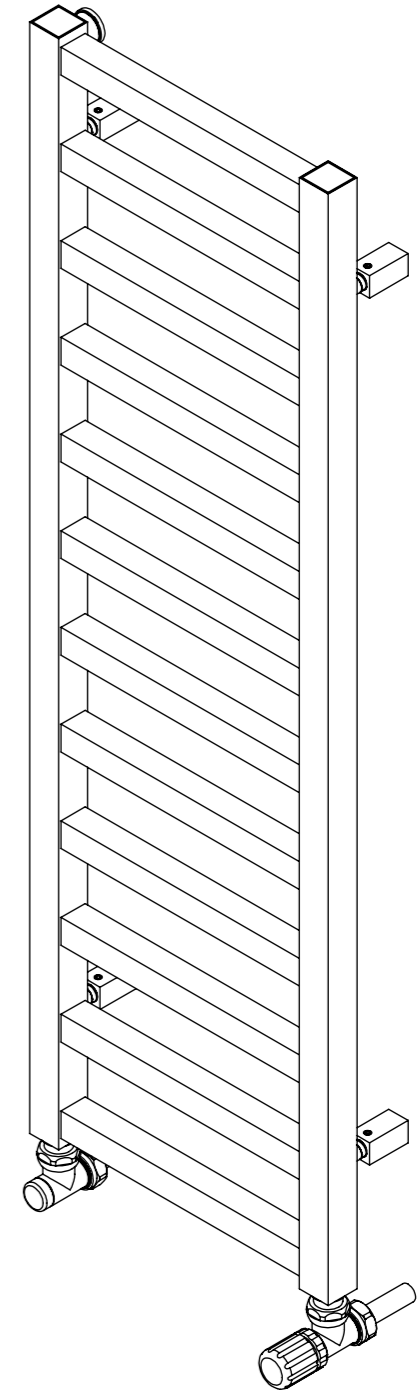



Back View



Top View

Installation Accessories:

- | | |
|-----------------------------------------------------------------------------------------|------------------------------------------------------------------------------------------|
|  x4 |  x4 |
|  x4 |  x4 |
|  x4 |  x1 |

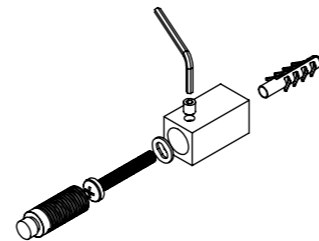

Fitting Position:

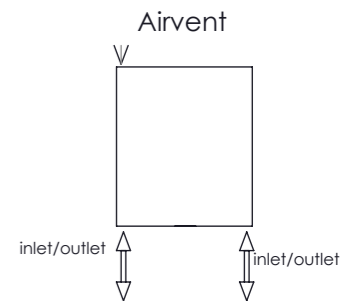

All Dimensions are in mm
 Max. Working Pressure: 10 Bar
 Max. Working Temperature: 95° C
 Inlet / Outlet : 1/2" BSP
 Fuel Type: H

ALL MEASUREMENTS ARE IN MILLIMETRES MANUFACTURED FROM MILD STEEL

3K14

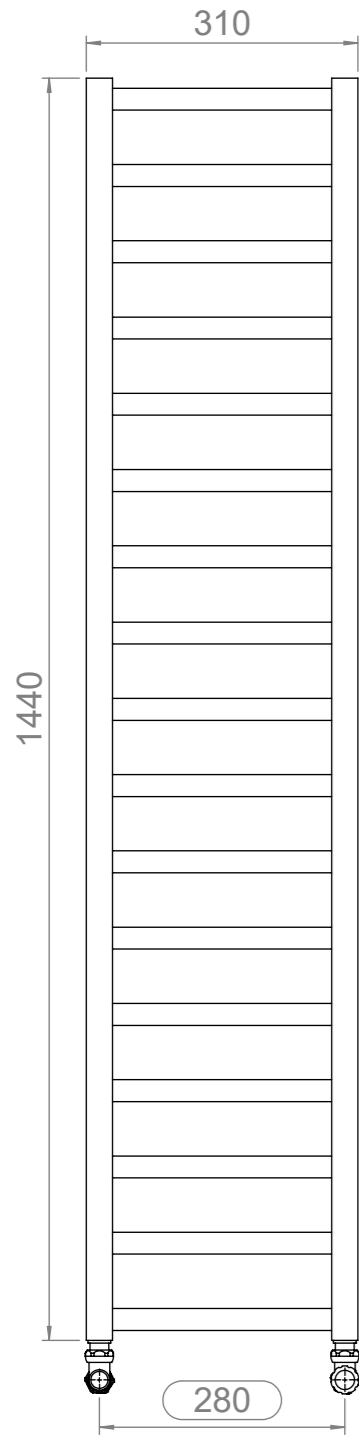

Front View

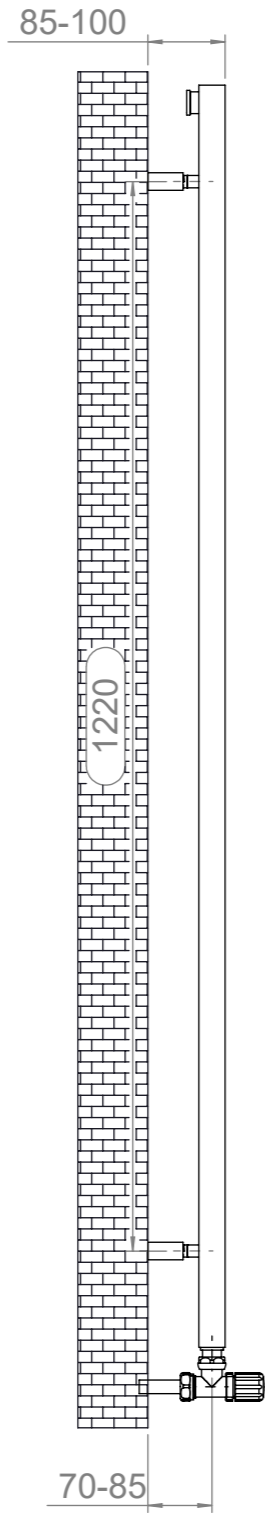

Side View

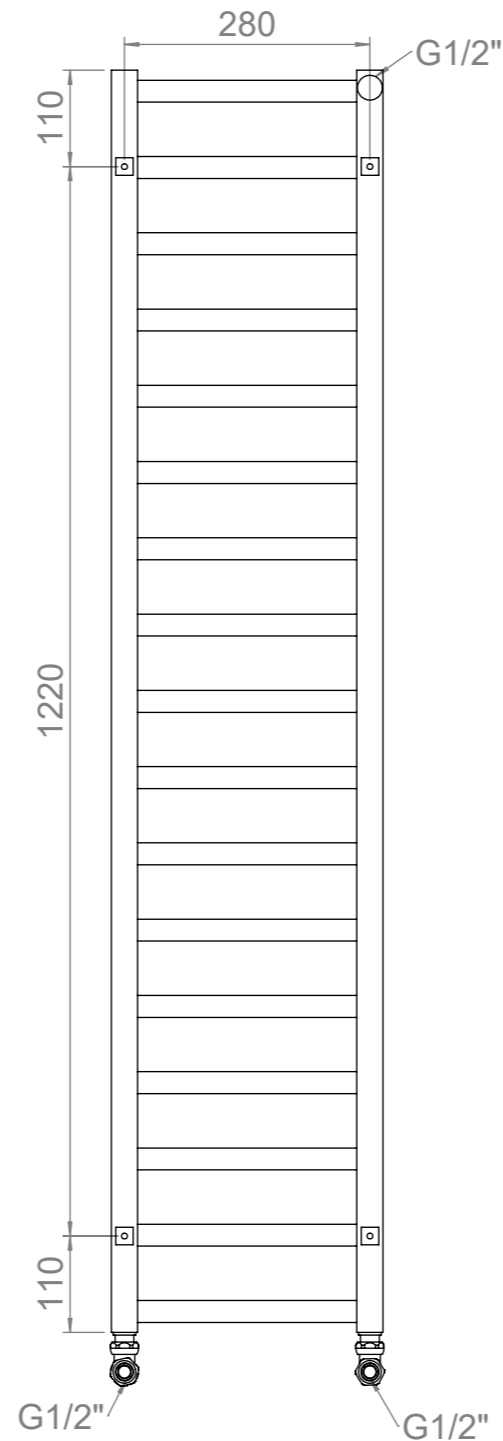



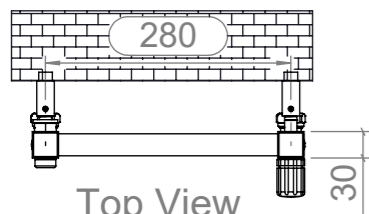
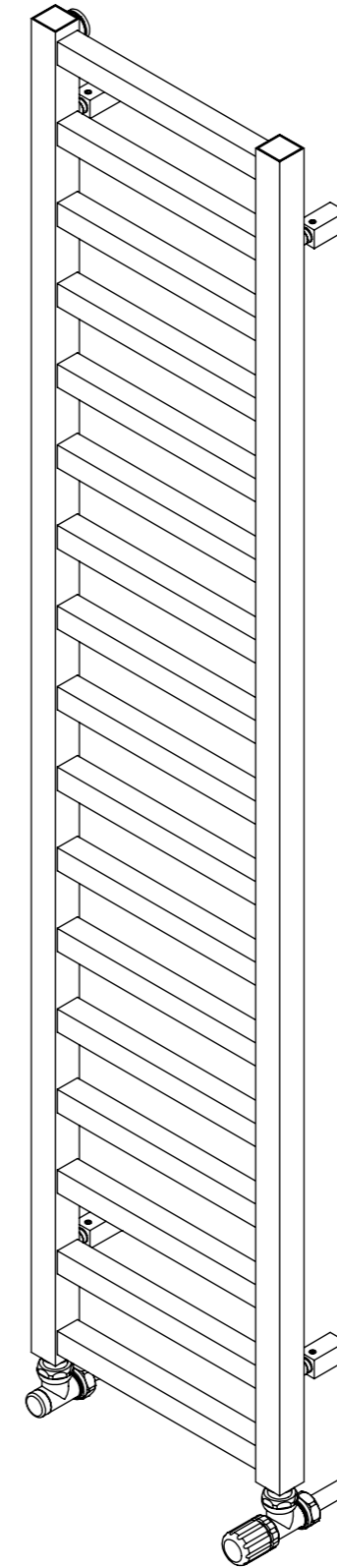

Back View

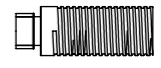
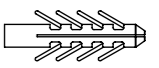

Top View

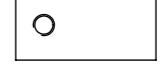
Installation Accessories:

-  x4  x4
-  x4  x4
-  x4  x1

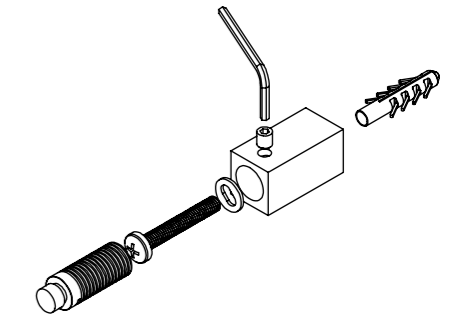

Fitting Position:

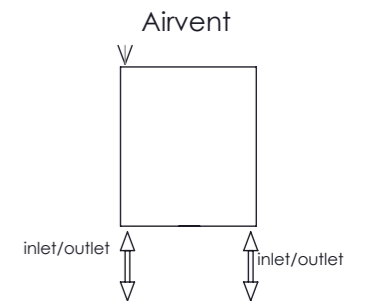





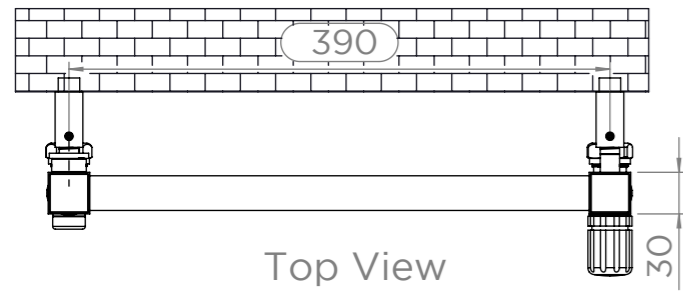
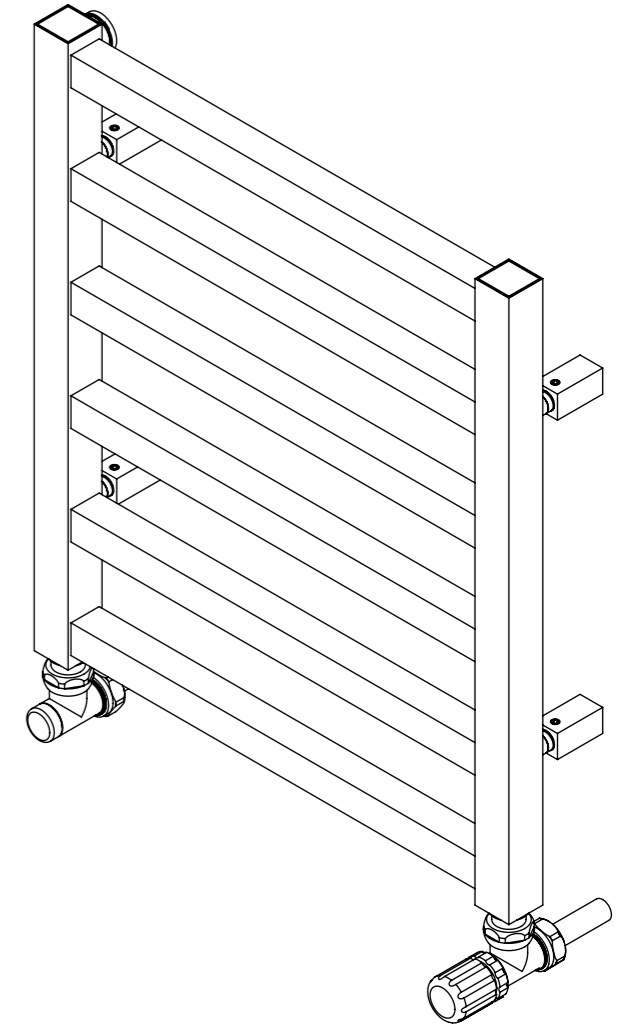
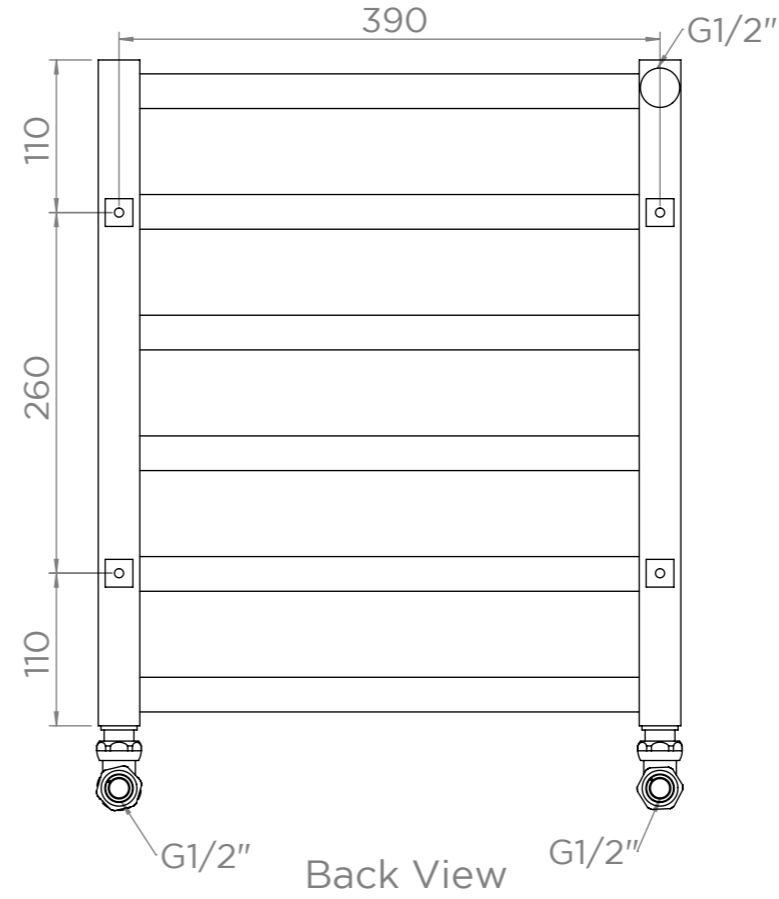
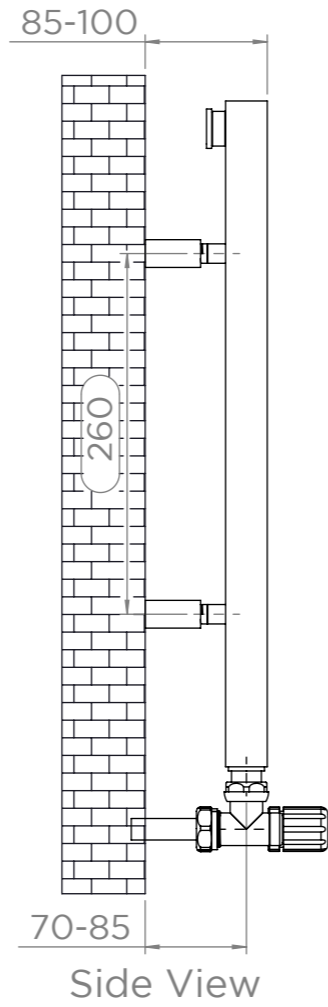
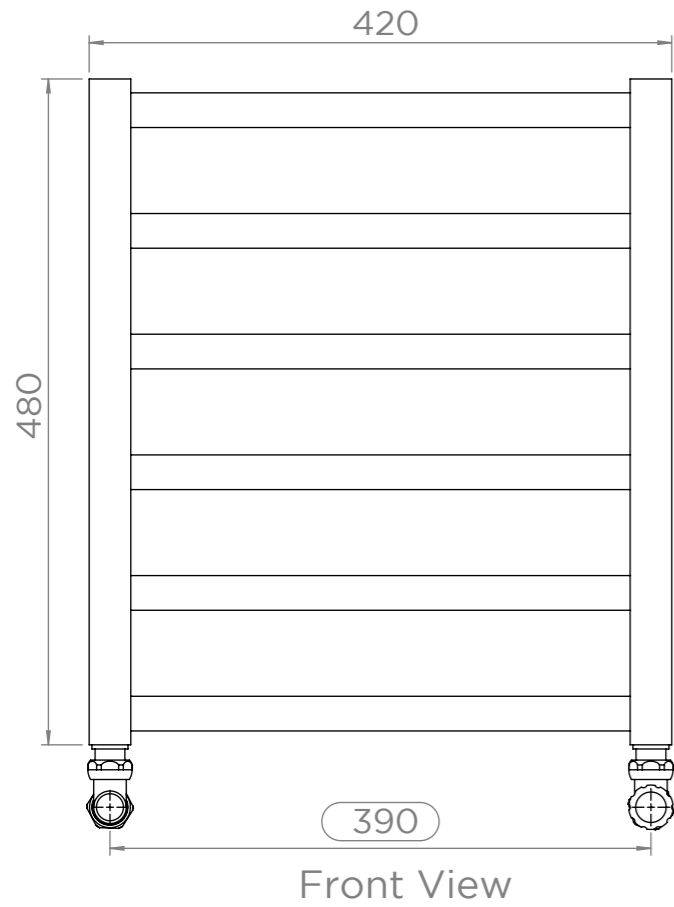

All Dimensions are in mm
 Max. Working Pressure: 10 Bar
 Max. Working Temperature: 95° C
 Inlet / Outlet : 1/2" BSP
 Fuel Type: H

ALL MEASUREMENTS ARE IN MILLIMETRES | MANUFACTURED FROM MILD STEEL

4K5



Installation Accessories:

- | | |
|----------------------------------------------------------------------------------------|----------------------------------------------------------------------------------------|
|  x4 |  x4 |
|  x4 |  x4 |
|  x4 |  x1 |

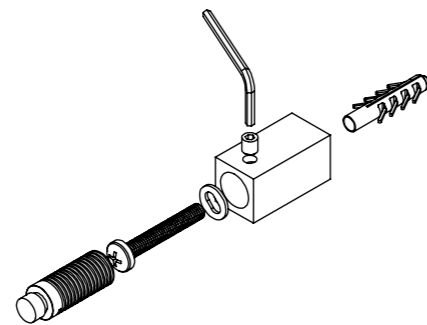

Fitting Position:

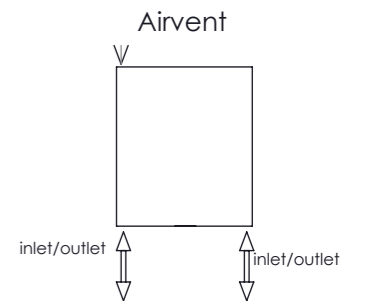

All Dimensions are in mm
 Max. Working Pressure: 10 Bar
 Max. Working Temperature: 95° C
 Inlet / Outlet : 1/2" BSP
 Fuel Type: H

ALL MEASUREMENTS ARE IN MILLIMETRES | MANUFACTURED FROM MILD STEEL

5K10

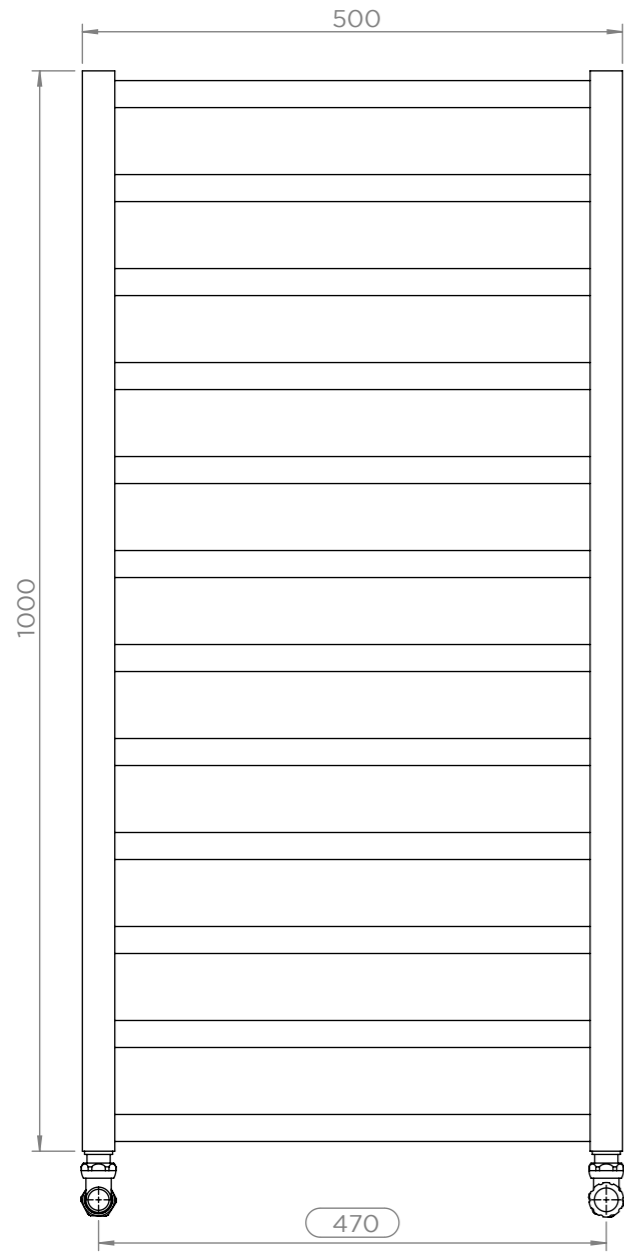

Front View

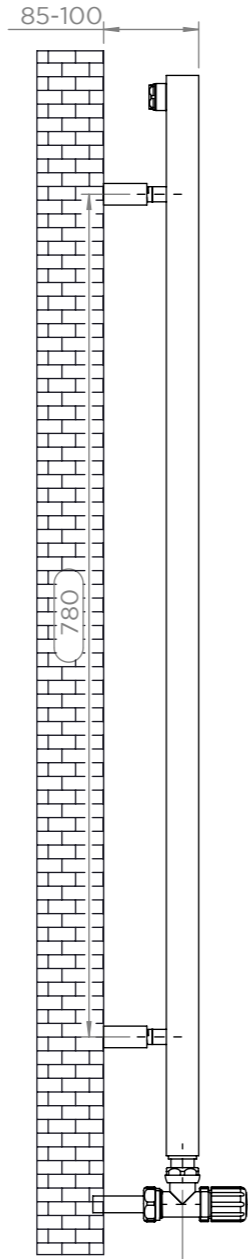

Side View

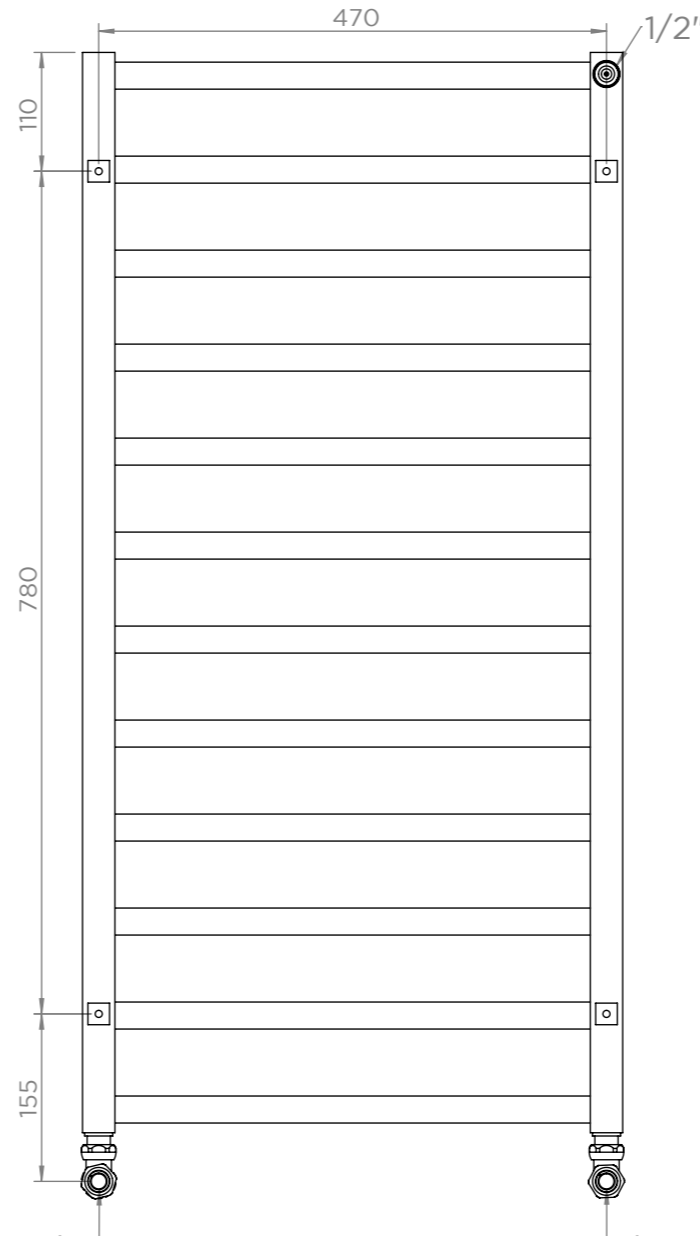

Back View

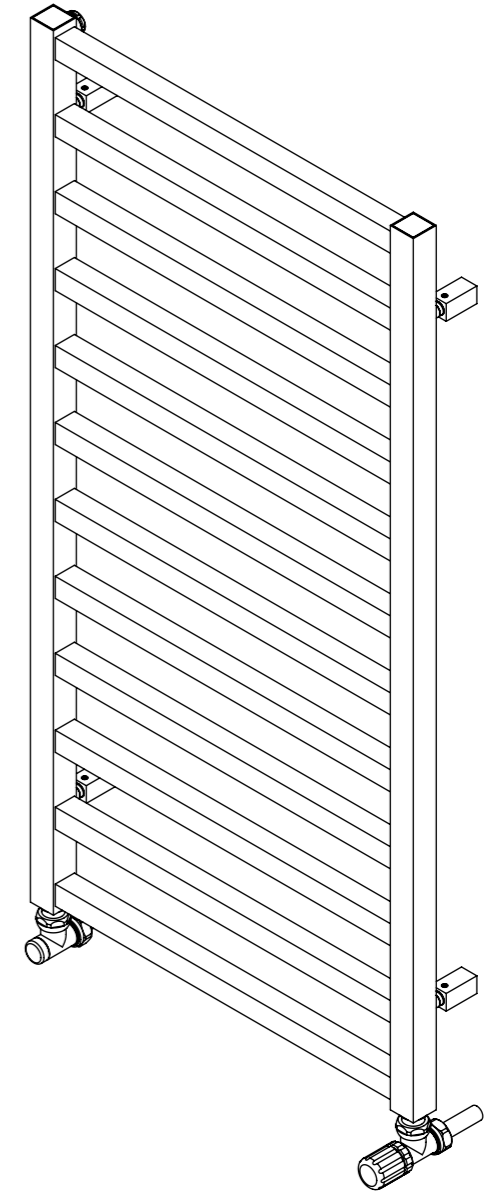



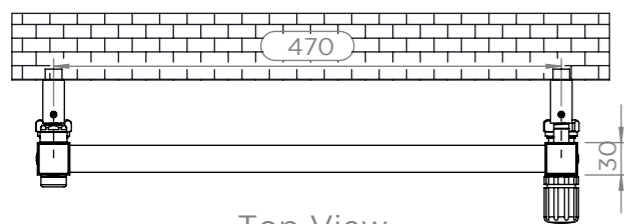
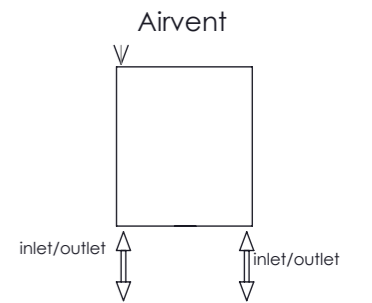



Fitting Position:

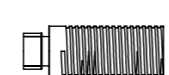

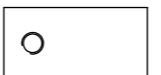
Top View

Installation Accessories:

-  x4
-  x4
-  x4
-  x4
-  x4
-  x1

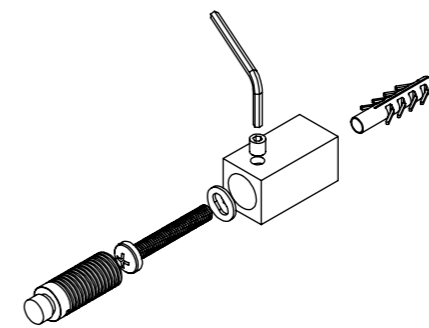





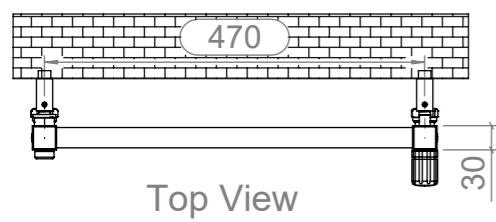
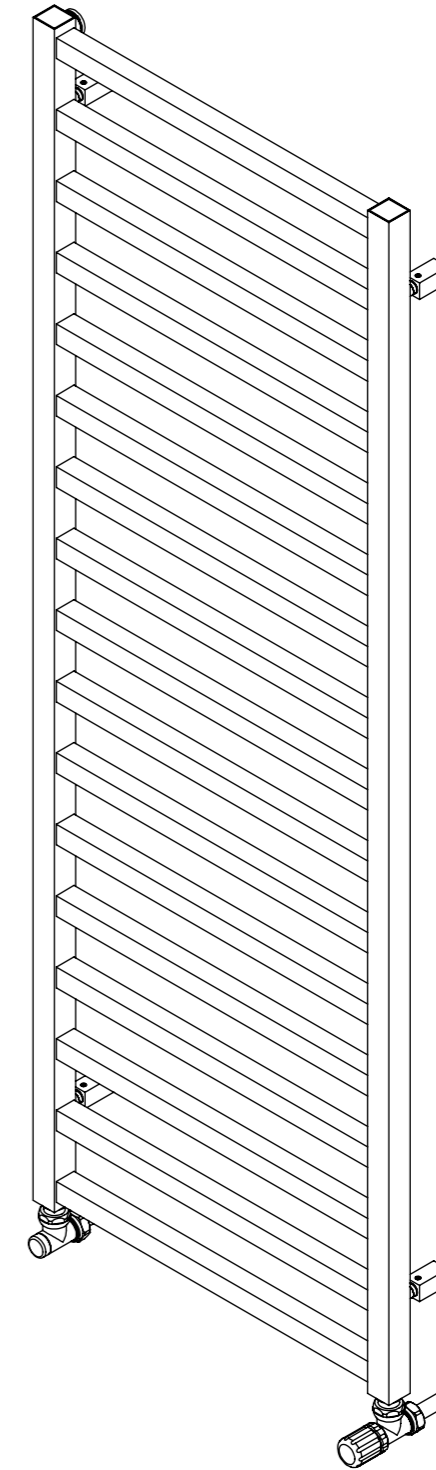
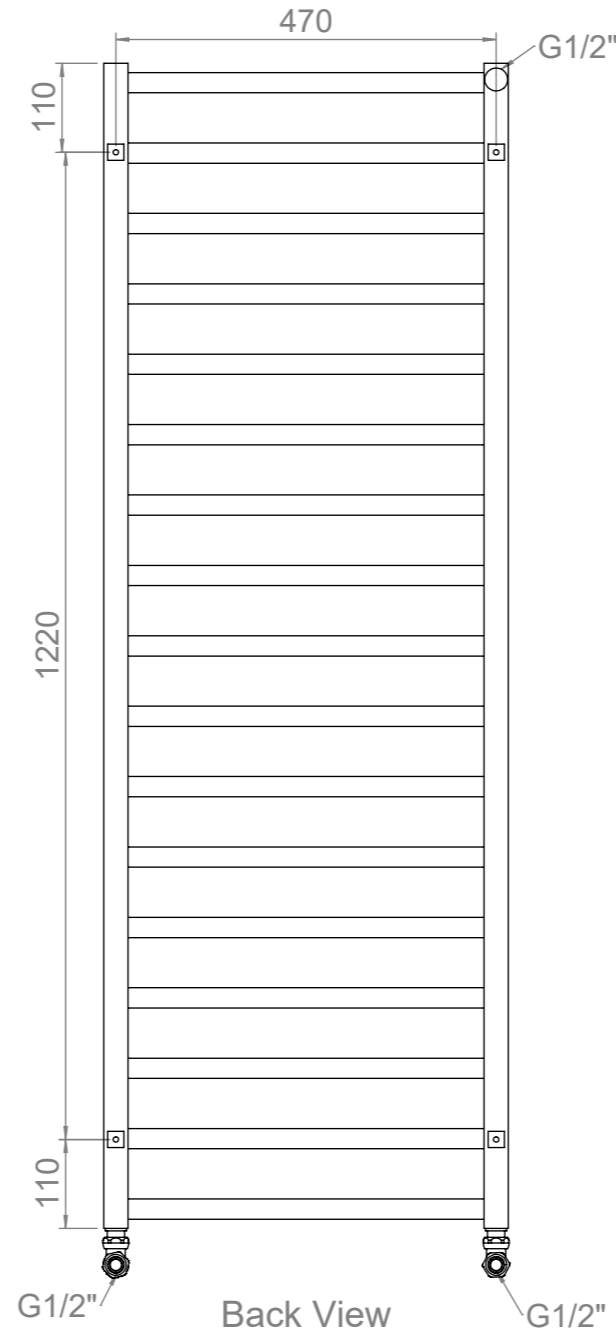
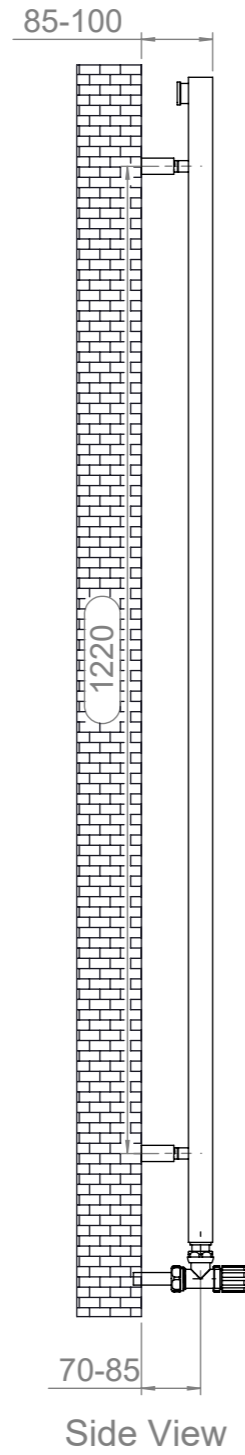
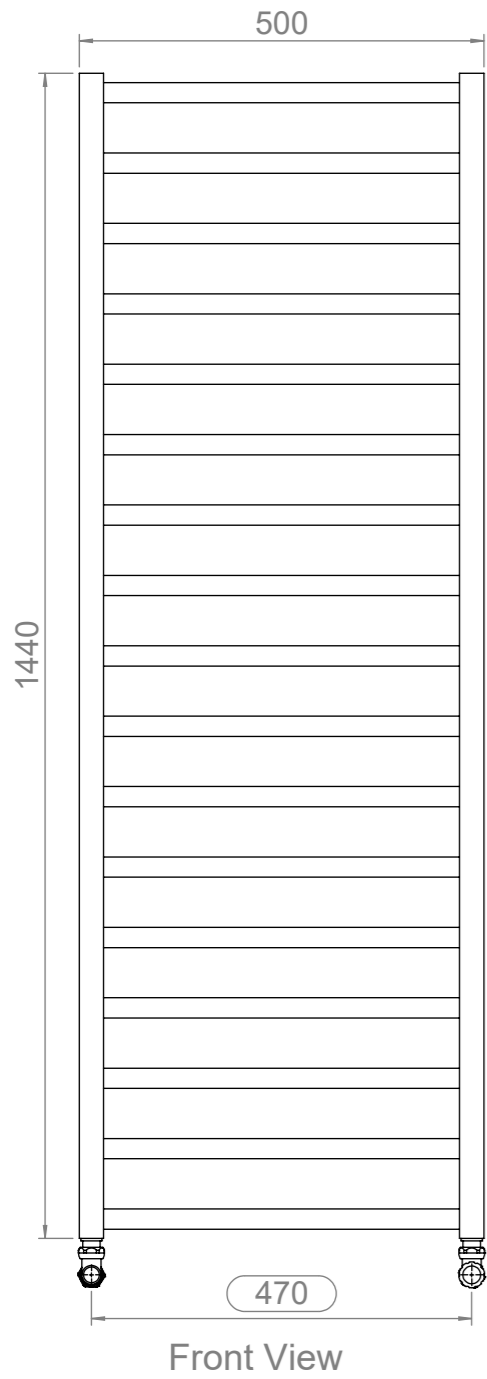

All Dimensions are in mm
 Max. Working Pressure: 10 Bar
 Max. Working Temperature: 95° C
 Inlet / Outlet : 1/2" BSP
 Fuel Type: H

ALL MEASUREMENTS ARE IN MILLIMETRES | MANUFACTURED FROM MILD STEEL

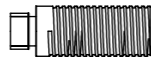
5K14



Installation Accessories:

-  x4
-  x4
-  x4
-  x4
-  x4
-  x1

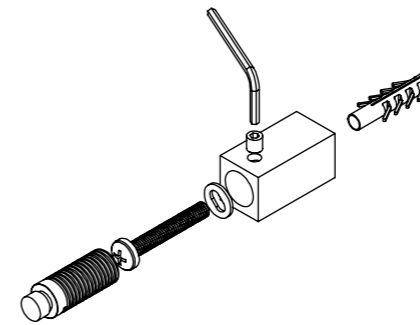

Fitting Position:

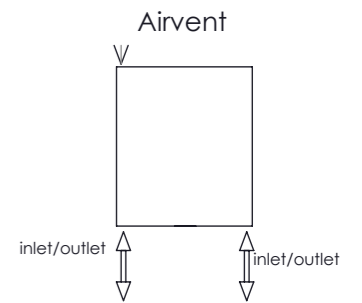

All Dimensions are in mm
 Max. Working Pressure: 10 Bar
 Max. Working Temperature: 95° C
 Inlet / Outlet : 1/2" BSP
 Fuel Type: H