

CENGIZ

INS-V2

ALL MEASUREMENTS ARE IN MILLIMETRES

MANUFACTURED FROM STAINLESS STEEL

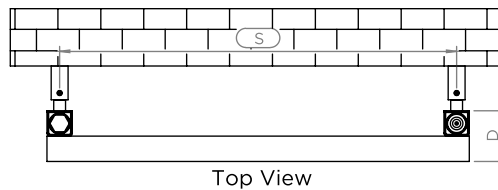
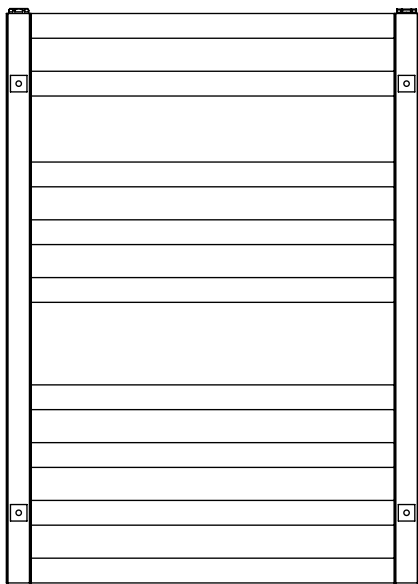
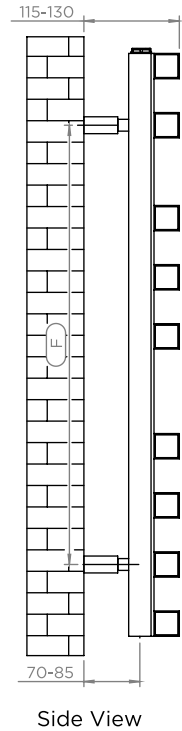
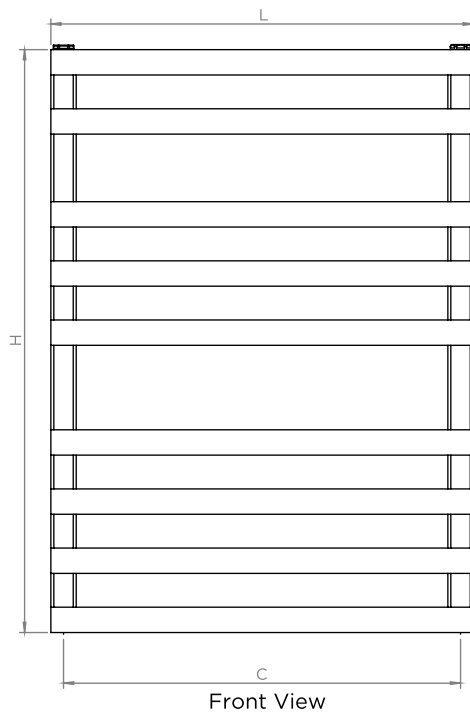
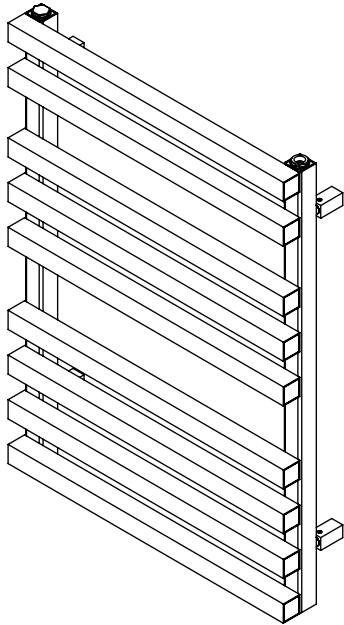

Manufacturing Tolerance: -5 Mm

PRODUCT CODE	HEIGHT	LENGTH	DEPTH	PIPE CENTRES	BRACKET CENTRES	
	H	L	D	C	F	S
	mm	mm	mm	mm	mm	mm
CEN5C7	690	500	60	470	520	470
CEN5C11	1100	500	60	470	930	470
CEN5C17	1650	500	60	470	1480	470

FR.71-Rev.00

Installation Accessories

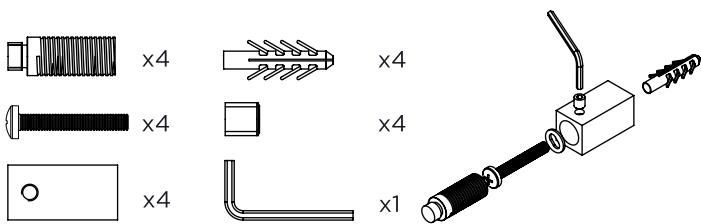

Fitting Position

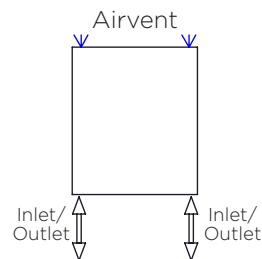

Vertical Mount
 All Dimensions are in mm
 Max.Working Pressure = 10 Bar
 Max.Working Temperature = 95°
 Inlet/Outlet: 1/2" BSP
 Fuel: E/H/D

Technical specifications are subject to change without prior notice.



AEON is the designer heating division of Pitacs Limited.
 Pitacs Limited, Bradbourne Point, Bradbourne Drive, Tilbrook, Milton Keynes,
 Buckinghamshire, MK7 8AT, UK

T: +44 (0)1908 271155 E: info@pitacs.com W: www.aeon.uk.com