

Zehnder Valve Set 19

always the
best climate **zehnder**

Tools & Material Required

Spanner - 29mm
Adjustable Spanner

Key	Component	Qty
A	Manual Body (flow)	1
B	Manual Body (return)	1
C	Nut	2
D	Valve Tail (1/2" BSP)	2
E	Compression Fitting (15mm)	2
F	Blanking Cap - Fixed	1
G	Blanking Cap - Removable	1
H	Balancing Cap	1

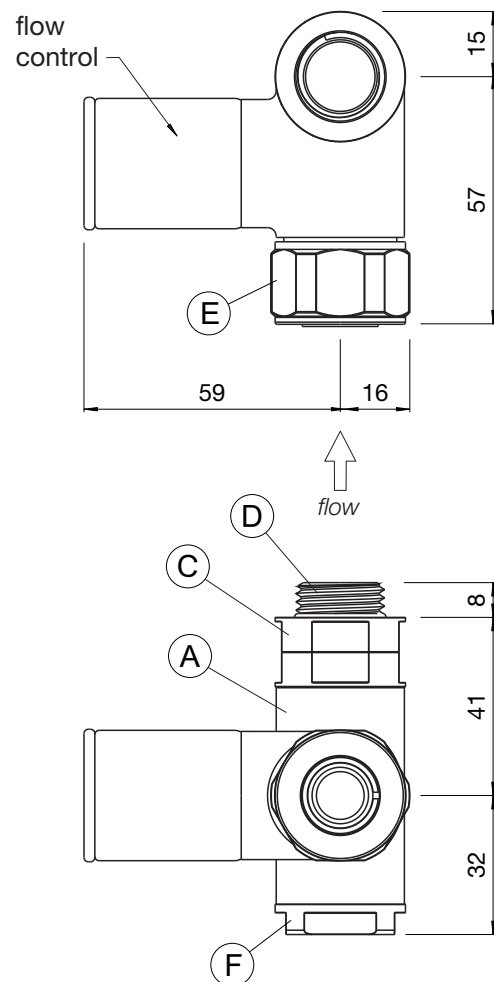
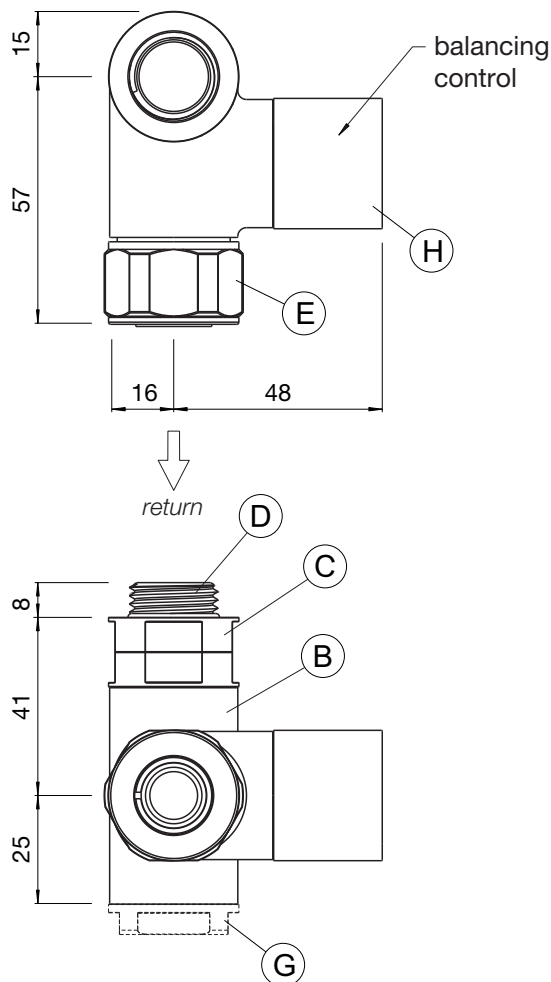

Assembly Instructions

Fit valve tails (D) to radiator, ensuring nut (C) is in place.

Note: over-tightening of valve tails may cause damage to surface finish of radiator connections. Do not use grips.

Loosen compression fittings (E) and apply valve bodies (A) & (B) to 15mm pipe tails.

Install radiator onto bracket mountings and tighten valve tails (D) onto valve bodies (A) & (B).

Tighten compression fittings (E).

If fitting supplementary heater (available separately), remove blanking cap (G) on return side.

After filling and venting radiator, remove balancing cap (H) and adjust balancing control to balance radiator.

Issue 1.0



Zehnder Group UK Ltd

Concept House
Watchmoor Point
Camberley
Surrey GU15 3AD

Tel: 01276 605800
Fax: 01276 24058
retailsales@zehnder.co.uk
www.zehnder.co.uk

Registered in England: 2296696