

ASHBY

Ladder Rail

STOCK

NEXT DAY OPTION

10 YEAR GUARANTEE

- Italian design & manufacture
- 50mm x 10mm Cross Tubes
- +Valves prices include Chrome DRAKE Valves*
- White RAL 9016 as standard delivered in 48-72 hours
- Optional next day delivery available in White RAL 9016 (page 2)
- 25 RAL colours and 8 special finishes delivered in up to 15 working days (page 11)

Pipe Centres and Technical Drawings

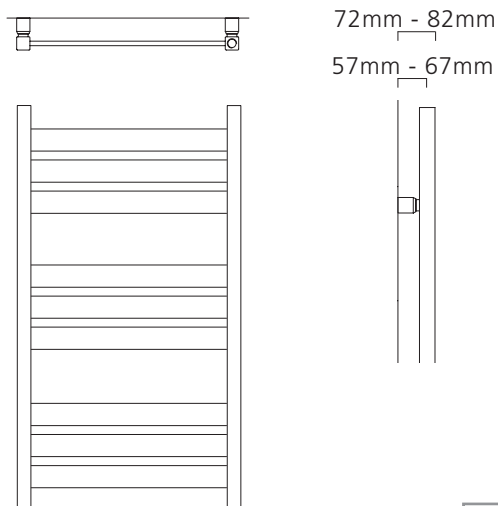

Pipe centres left to right = Width less 30mm
Pipe centres from wall = 57mm - 67mm
Depth from wall = 72mm - 82mm

+Valves Prices include Angled Chrome DRAKE Valves



Please specify at time of order



◆1640mm x 500mm in White RAL 9016 shown with LIVINGSTONE Valves.

Sizes and Prices

Dimensions (mm)		Cross Tubes	Output Δt 50°C		Product Code
Height	Width		Watts	Btu's	
940	500	9	383	1307	ASHB945009
	600	9	430	1467	ASHB946009
1290	500	12	526	1795	ASHB125012
	600	12	590	2013	ASHB126012
1640	500	15	669	2283	ASHB165015 ◆
	600	15	749	2556	ASHB166015

Ashby Fitting Instructions

Steel Flat Tube Towel Rail

Please read these instructions and terms and conditions carefully prior to installation. Failure to do so may invalidate the warranty.



Cod.938M0718

Drawings

H mm
800
1080
1220
1500

● = Bracket position

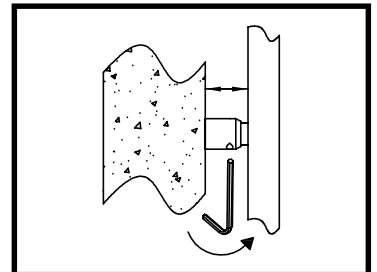
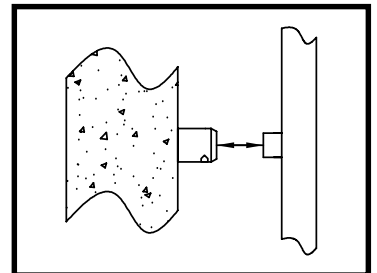
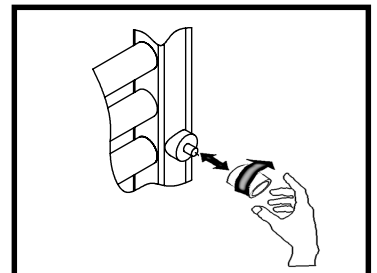
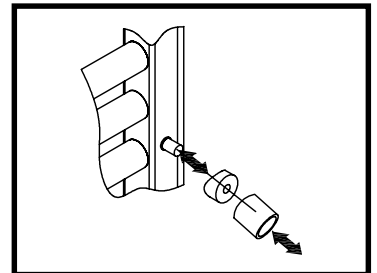
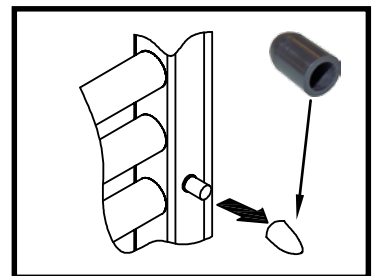
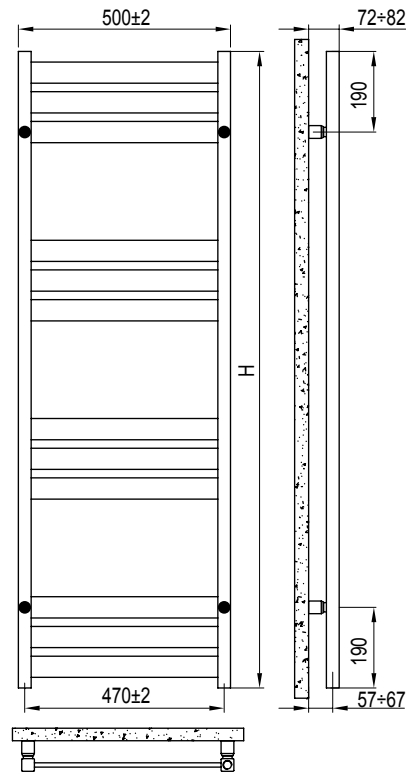

Pipe Centres

Pipe centres left to right	=	width less 30mm
Pipe centres from wall	=	57mm - 67mm
Depth from wall	=	72mm - 82mm

www.supplies4heat.co.uk 01342 306880

1. Unpack & Inspect

This product should have reached you in perfect condition. Please carefully unpack and inspect this radiator and all fittings. Your point of purchase must be notified of any shortages or damage within 28 days of delivery.

For further information please see terms and conditions at the bottom of the page.

3. Fix Brackets

Using the dimensions in the diagrams overleaf, the two top brackets are positioned at 470 mm apart and 190 mm down from the top of the towel rail.

Mark the positions on the wall, and offer up the radiator to check before drilling. Ensure they are horizontally level then using a suitable drill bit, screws and plugs hang the bracket sleeves on the wall. Slot in the radiator to check the positions. To firmly fix the radiator, tighten the grub screws on the side of the brackets to secure.

We suggest you fix the top two brackets, then holding the radiator in place, mark the position for the bottom two brackets to ensure accuracy then fix.

PLEASE NOTE:

It is essential that all brackets are level and square prior to hanging the radiator to ensure a vertical alignment for connecting the pipework.

2. Contents

You should have:

- 1 Radiator
- 4 Wall Bracket
- 1 Manual Airvent

You will need:

- Tape measure
- Electric drill and bits
- Spirit level

The fixing kits (screws and dowels) are suitable for compact walls or hollow bricks. Please ensure suitable fixings are used for the correct wall type.

4. Hang & Commission Radiator

When commissioning your radiator on an indirect/closed system we recommend using a suitable quality and quantity of mixed metal inhibitor to protect against scale & corrosion.

Damage caused to systems not protected by a suitable inhibitor will not be covered by manufacturer's guarantee.

PLEASE NOTE: Systems using micro bore pipe work must have adequate pressure and flow rates for the number and style of radiators on the system.

Technical Specifications

Materials	Steel
Connections	½" flow and return.
Test pressure	4.5 Bar
Testing authority	EN442
Maximum operating pressure	3.5 Bar
Maximum working temperature	95°C
Packaging	Wrapped in polythene and boxed

Guarantees & Liabilities

This product is guaranteed for 10 years. The guarantees in all cases are subject to the products being installed in accordance with British and or European standards as well as these fitting instructions. The guarantees in all cases are restricted to the free of charge replacement or repair of the failed product only. Our liability will under no circumstances extend beyond the repair or replacement of the product supplied by us. Claims for either labour in replacement or damage to property are not admissible. Any goods that are returned, in the event of a problem, will belong to us.

Terms & Conditions

All products must be inspected once removed from the packaging and your point of purchase notified within 28 days of delivery of any scratches, blemishes or other damage. Your point of purchase will then agree appropriate action.

Imperfect radiators should therefore not be fitted and we will not accept responsibility for replacement of scratched or damaged radiators once they have been fitted. This includes any consequential loss or cost of fitting.

If we are not notified within 28 days of the date on the signed delivery note then it will be deemed that we have fully complied with our obligations and claims will not be considered.

Failure to comply with any of the above may invalidate any claims. We recommend that after you check the product on delivery that it is stored in its packaging to prevent damage prior to installation, we cannot accept responsibility for items damaged after delivery.

For full details of our Terms and Conditions please visit www.supplies4heat.co.uk or call us on 01342 306880.