

# Harmonique MD060 1200x500

Height: 1200  
Width: 500  
Depth: 93  
Weight HO: 14.5 kg  
EO: 28.5 kg

Tube  $\phi$  : 25 + 40x30 D Section  
Pipe Centres: 464  
Elec. element if specified: 300  
Output @ 50°C  $\Delta$  T Watts: 834  
BTUs: 2846

All dimensions in millimetres

Manufactured from Mild Steel

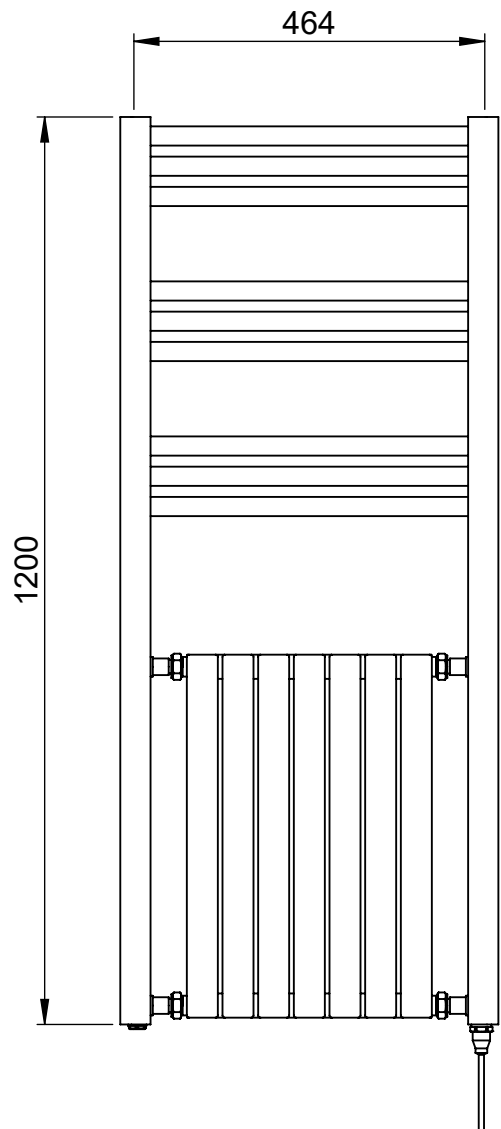
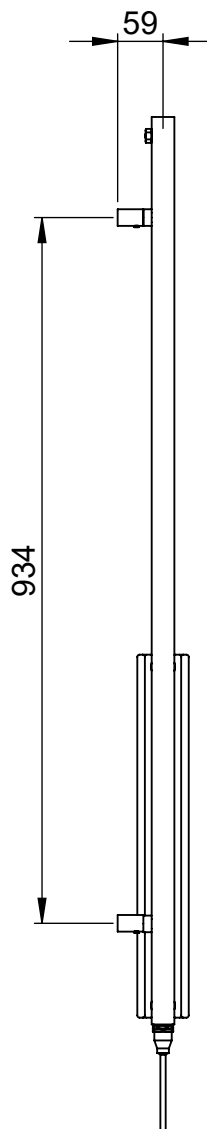
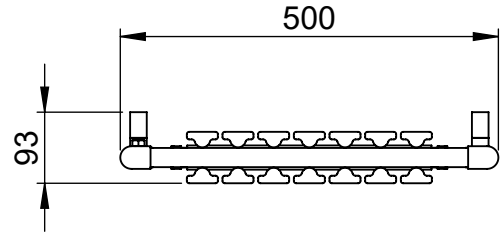
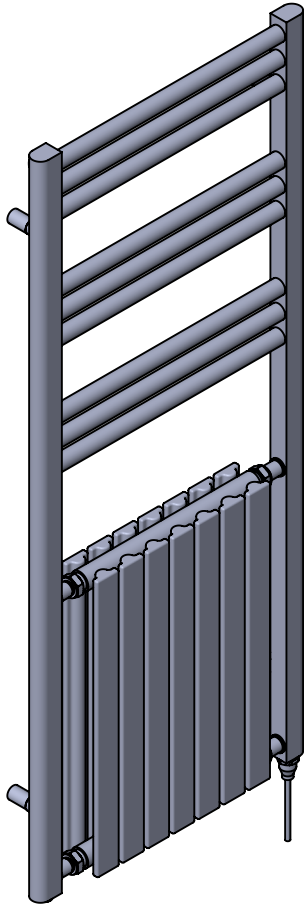

Vogue UK Ltd. reserve the right to alter specifications without prior notice.  
ALL MEASUREMENTS ARE NOMINAL DIMENSIONS ONLY, AND ARE NOT BINDING.



SCALE 1:10



**VOGUE UK**  
TOWEL WARMERS & RADIATORS

Strawberry Lane, Willenhall  
West Midlands WV13 3RS  
Tel: 01902 387000 Fax: 01902 387001  
e-mail: sales@vogueuk.co.uk www.vogueuk.co.uk

# HarmoniqueMD060 1200x600

Height: 1200

Width: 600

Depth: 93

Weight HO: 17.5 kg

EO: 22.5 kg

Tube  $\phi$  : 25 + 40x30 D Section

Pipe Centres: 564

Elec. element if specified: 400

Output @ 50°C  $\Delta$  T Watts: 1033

BTUs: 3525

All dimensions in millimetres

Manufactured from Mild Steel

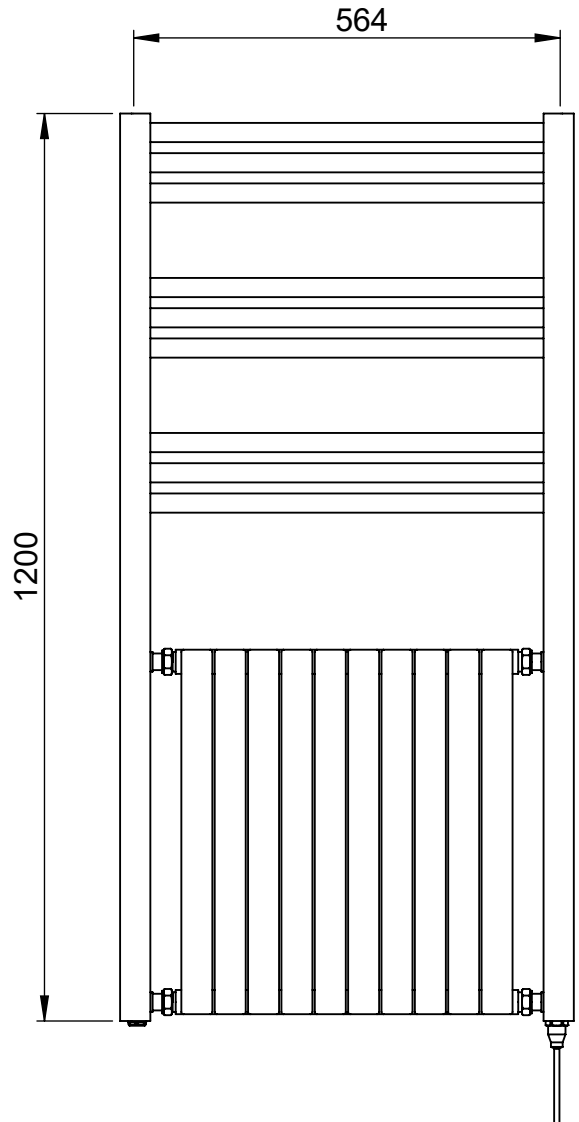
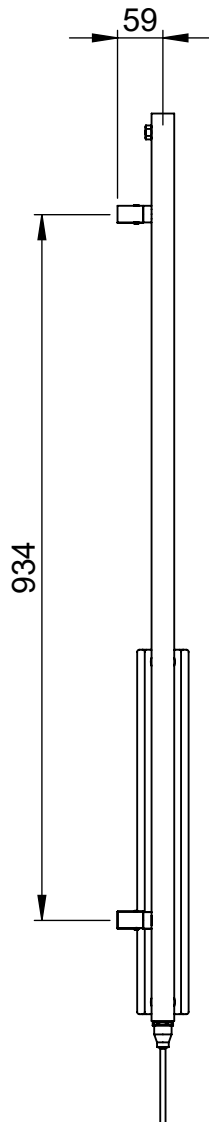
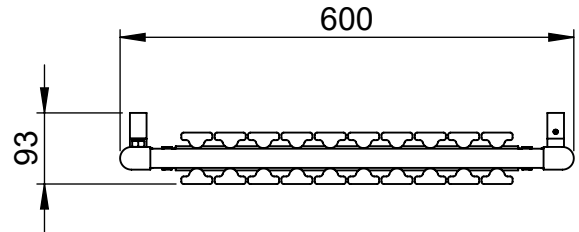
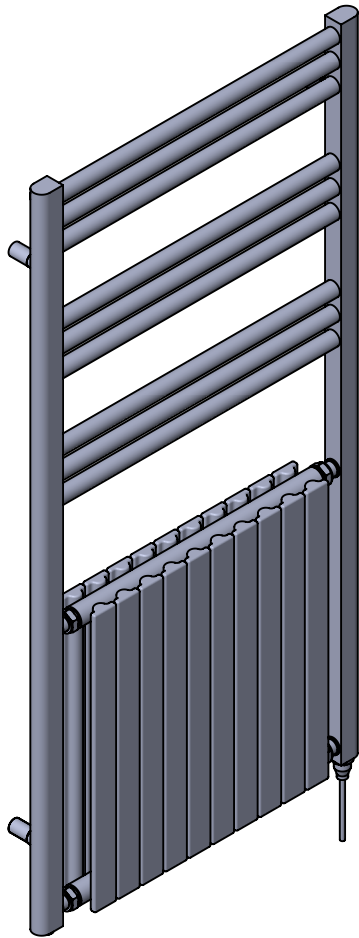

Vogue UK Ltd. reserve the right to alter specifications without prior notice.  
ALL MEASUREMENTS ARE NOMINAL DIMENSIONS ONLY, AND ARE NOT BINDING.



SCALE 1:10



**VOGUE UK**

TOWEL WARMERS & RADIATORS

Strawberry Lane, Willenhall  
West Midlands WV13 3RS  
Tel: 01902 387000 Fax: 01902 387001  
e-mail: sales@vogueuk.co.uk www.vogueuk.co.uk

# Harmonique MD060 1500x500

Height: 1500  
Width: 500  
Depth: 93  
Weight HO: 19.5 kg  
EO: 28.5 kg

Tube  $\phi$  : 25 + 40x30 D Section  
Pipe Centres: 464  
Elec. element if specified: 400  
Output @ 50° C  $\Delta$  T Watts: 1145  
BTUs: 3907

All dimensions in millimetres

Manufactured from Mild Steel

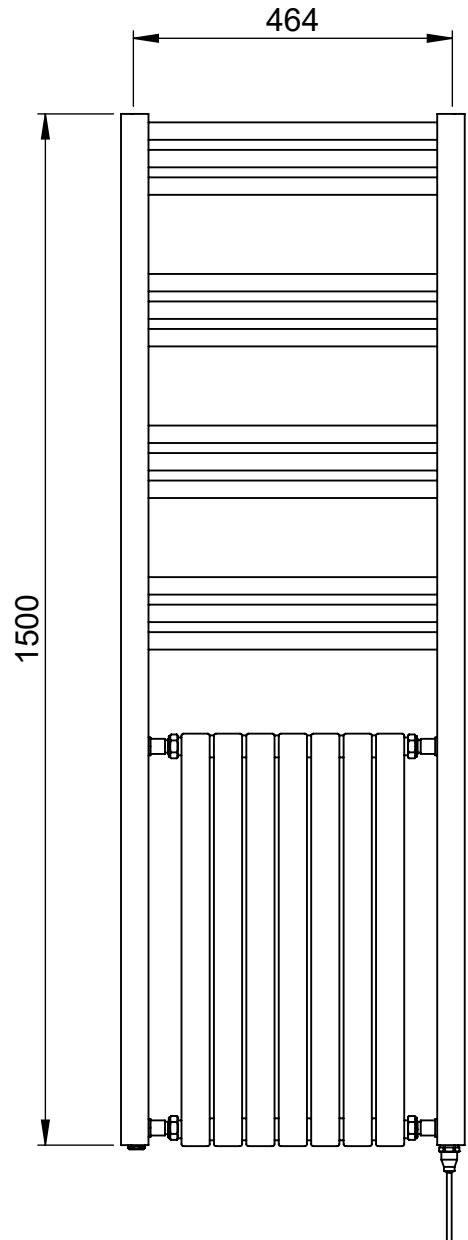
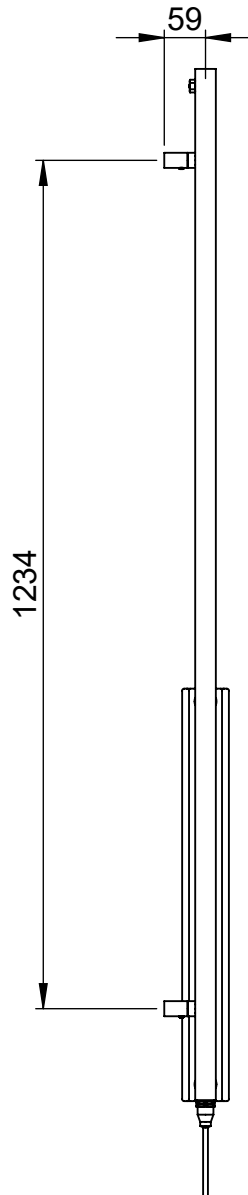
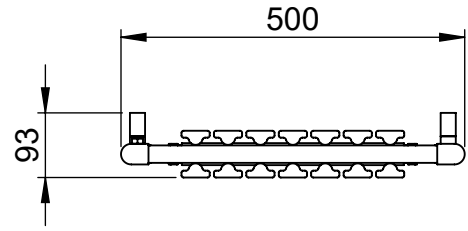
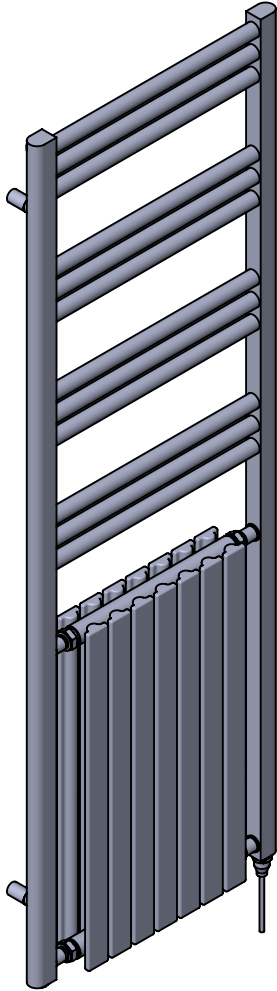

Vogue UK Ltd. reserve the right to alter specifications without prior notice.  
ALL MEASUREMENTS ARE NOMINAL DIMENSIONS ONLY, AND ARE NOT BINDING.

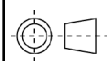

SCALE 1:20



**VOGUE UK**  
TOWEL WARMERS & RADIATORS

Strawberry Lane, Willenhall  
West Midlands WV13 3RS  
Tel: 01902 387000 Fax: 01902 387001  
e-mail: sales@vogueuk.co.uk www.vogueuk.co.uk

# Harmonique MD060 1500x600

Height: 1500  
Width: 600  
Depth: 93  
Weight HO: 21.5 kg  
EO: 31.5 kg

Tube  $\phi$  : 25 + 40x30 D Section  
Pipe Centres: 564  
Elec. element if specified: 400  
Output @ 50° C  $\Delta$  T Watts: 1438  
BTUs: 4906

All dimensions in millimetres

Manufactured from Mild Steel

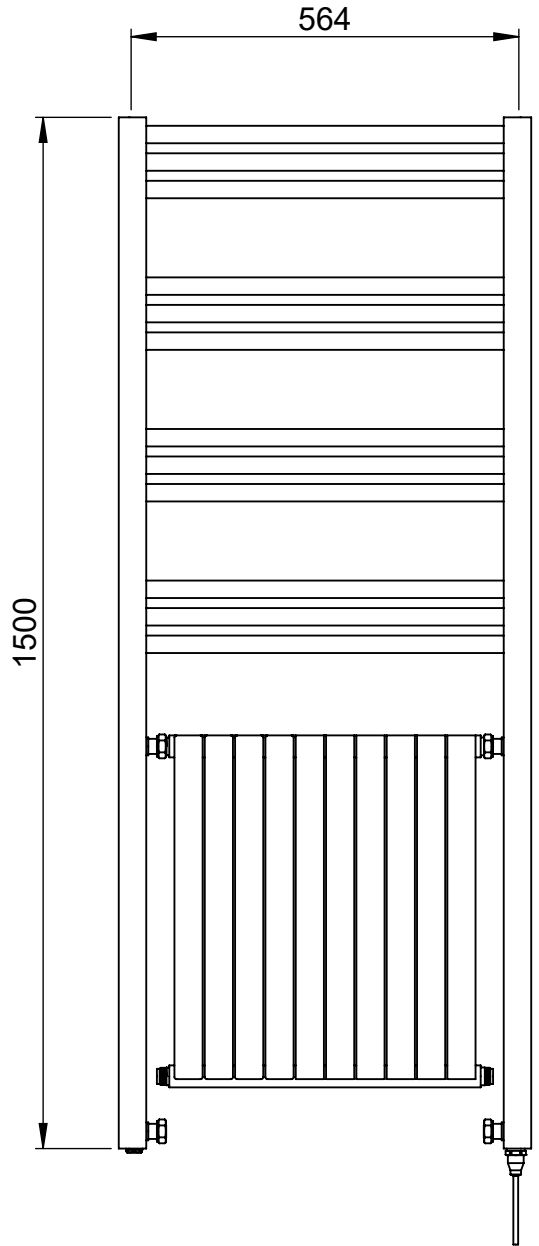
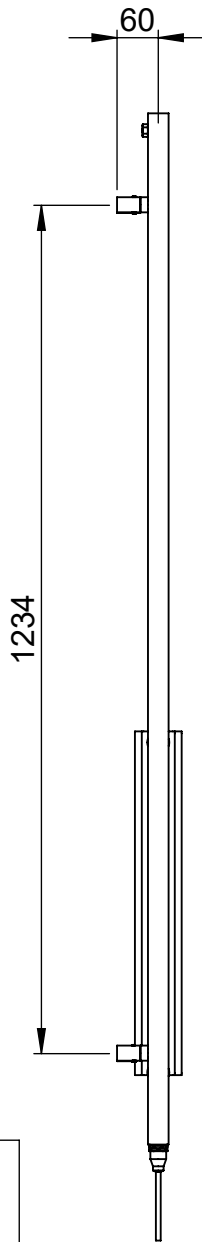
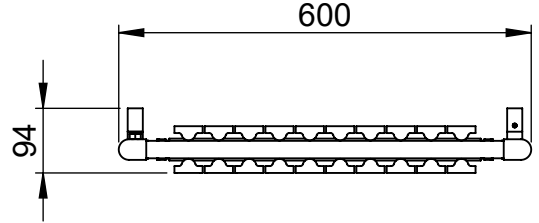
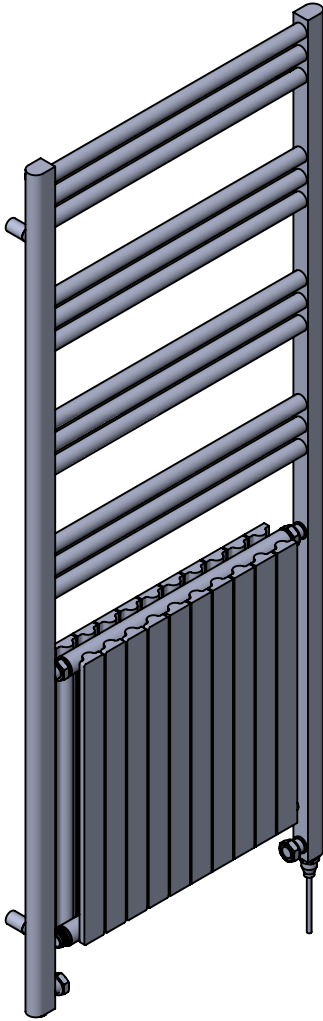

Drawn on(Date): 02/2021

Approved By:

Vogue UK Ltd. reserve the right to alter specifications without prior notice.  
ALL MEASUREMENTS ARE NOMINAL DIMENSIONS ONLY, AND ARE NOT BINDING.



SCALE 1:20



**VOGUE UK**  
TOWEL WARMERS & RADIATORS

Strawberry Lane, Willenhall  
West Midlands WV13 3RS  
Tel: 01902 387000 Fax: 01902 387001  
e-mail:sales@vogueuk.co.uk www.vogueuk.co.uk