



**ELECTRIC MODEL
AVAILABLE**

Please see page 208



COLUMN



The COLUMN range from MYSON combines elegant style with practical design. At the forefront of the design radiator revolution, the COLUMN will make a focal point in any room. Available in vertical and horizontal models and in a selected range of colour options and sizes, the COLUMN radiator creates a selection of new interior design possibilities for you.

- There are over 60 stocked models available, with heights ranging from 300mm to 2000mm and lengths from 300mm to 1800mm
- Manufactured using a unique laser welding process that virtually eliminates the visible welding points
- The COLUMN radiator is also available as an electric model for instant heat as well as style, please see page 208



COLUMN HORIZONTAL

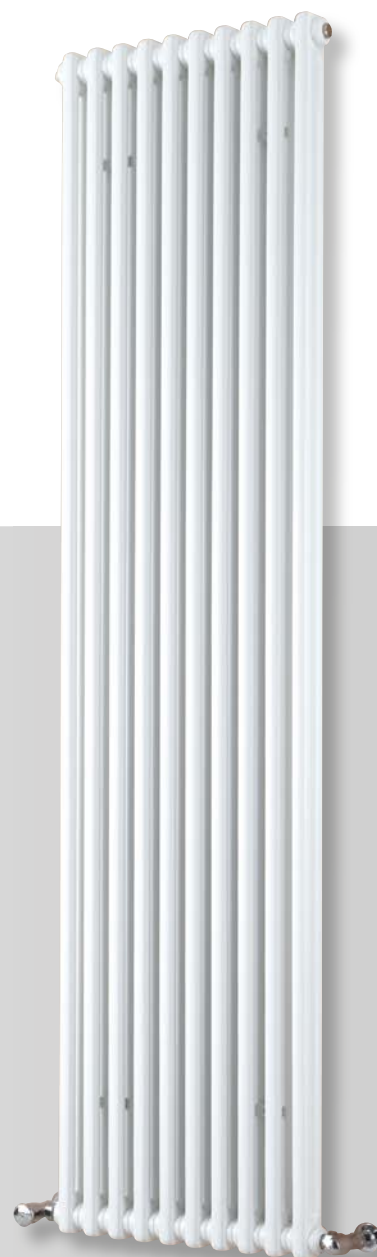

COLUMN VERTICAL

COLUMN

General specification & technical information



CERTIFICATION

Manufactured and tested to EN 442. Carries the CE Mark. Produced under a quality management system - ISO 9001:2015, environmental management system - ISO 14001:2015 and Occupational health and safety management system - OHSAS 18001.



GUARANTEE

10 year guarantee from date of purchase against manufacturing defects.



COLOUR

Standard stocked finish is white (RAL 9016). For other special colour options please see page 262.



MATERIAL

Manufactured from 1.25mm steel.



ACCESSORIES

Please see page 87. Touch up paint available on request.



SYSTEM

2 pipe pumped indirect domestic and commercial heating applications.



CONNECTIONS

4 x 1/2" BSP as standard.



AIR VENTS

Air vent and plug packs are included in the packaging.



OPERATING PRESSURES

Tested to a pressure of 13 bar. Working pressure of up to 10 bar.



OPERATING TEMPERATURE

Maximum 100°C.



DELIVERY

Stocked items (white): 2 - 5 working days. Non-stocked items (colour): 4 - 6 weeks.



VALVES

Please see page 219.



BIM

Visit our website to download the BIM components www.myson.co.uk/bim



SPECIALS

Visit our website to download the BIM components www.myson.co.uk/bim

For more general information, please see page 260.

Weights & water contents per section

Columns	Nominal Height (mm)											
	300		450		600		750		1800		2000	
	Weight (kg)	Water Content (l)	Weight (kg)	Water Content (l)	Weight (kg)	Water Content (l)	Weight (kg)	Water Content (l)	Weight (kg)	Water Content (l)	Weight (kg)	Water Content (l)
2	-	-	0.75	0.53	0.98	0.66	-	-	2.82	1.72	3.12	1.90
3	0.78	0.57	1.12	0.76	1.46	0.96	1.79	1.15	-	-	-	-
4	1.05	0.75	1.49	1.01	1.94	1.26	2.39	1.51	-	-	-	-

n-Coefficients

Columns	Nominal Height (mm)					
	300	450	600	750	1800	2000
2	-	1.2325	1.2415	-	1.3197	1.3289
3	1.2270	1.2445	1.2604	1.2750	-	-
4	1.2297	1.2564	1.2793	1.2986	-	-

Mounting positions, dimensions & wall brackets

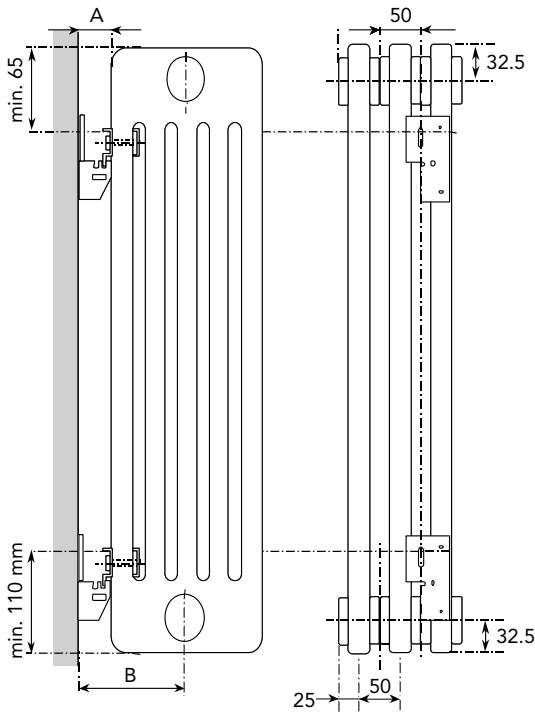

Model	Nominal Depth (mm)	A Distance from Wall (mm)	B Connection Distance from Wall (mm)
2 Column	63	31 / 41	63 / 73
3 Column	101	31 / 41	82 / 92
4 Column	139	31 / 41	101 / 111

Standard Brackets
(included with every product)

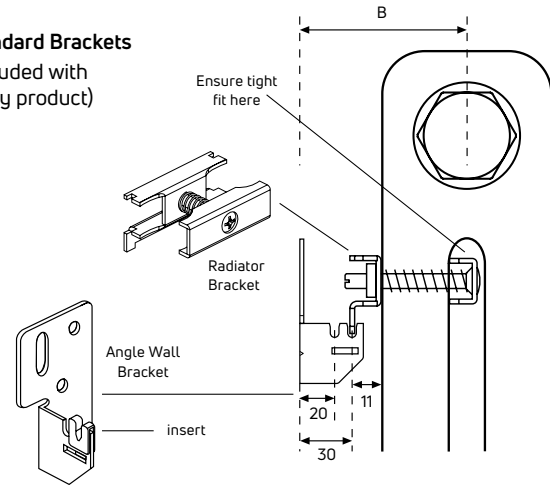

Floor brackets (optional extras)

Clamped Floor Bracket FK*

For use with 2-4 column radiators up to 500mm high

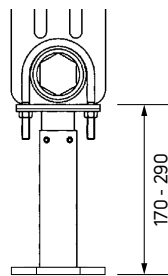
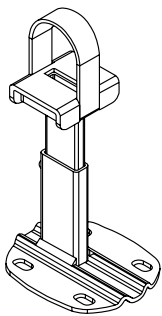

Complete system for free-standing radiators, from 2-4 column up to 500mm height. Finished in white (RAL 9016).

Comprises;

- 3mm thick base-plate fixing for either finished or unfinished floors.

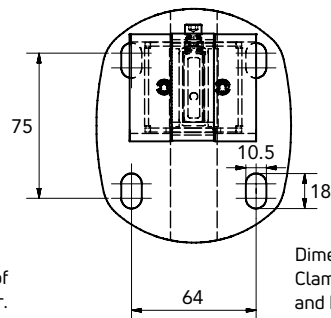

*Please contact Customer Services for correct number of brackets required per radiator.

Dimensions of base-plate for Clamped Floor Bracket FK and Floor Bracket SK

Floor Bracket SK*

For use with 2-4 column radiators up to 1000mm high

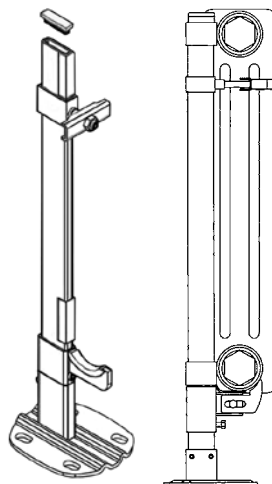

Complete system for free-standing radiators, from 2-4 column up to 1000mm height. Finished in white (RAL 9016).

Comprises;

- 3mm thick base-plate for fixing to either finished or unfinished floors
- upright support 35 x 10 x 1.5mm, fixing set with adjustable bracket, security fixing, anti-vibration insert
- adjustable bottom support with spacer and security fixing, anti-vibration insert, white plastic end stop for top of upright.

Two-part cover for base-plate in white plastic for Clamped Floor Bracket FK and Floor Bracket SK (Only available in white)

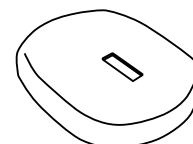

NB: All measurements are nominal.

COLUMN

Technical information (cont...)

Connection options

4 x 1/2" BSP

All MYSON COLUMN radiators are manufactured with an internal baffle to help with water flow. The tapping with the baffle is identified with a red plastic cap, all others being blue. It is important that the water inlet is connected to the tapping identified in red. All MYSON COLUMN radiators are reversible so any of the following connections are possible:

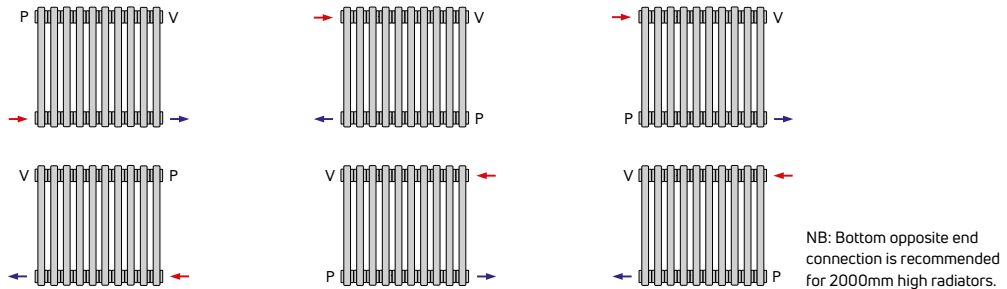

Heat outputs

COLUMN vertical - 2 column

	Nominal Height	Nominal Width (mm)	No. of Sections
	1800mm	300	6
		400	8
		500	10
		600	12
		750	15
	2000mm	300	6
		400	8
		500	10
		600	12
750		15	

Heat Outputs @ ΔT 50°C		Heat Outputs @ ΔT 30°C		Order Code
Watts	Btu/h	Watts	Btu/h	
793	2706	401	1368	6 SEC 2180
1058	3610	534	1822	8 SEC 2180
1322	4511	668	2279	10 SEC 2180
1587	5415	802	2736	12 SEC 2180
1983	6766	1002	3419	15 SEC 2180
880	3002	443	1512	6 SEC 2200
1174	4005	590	2013	8 SEC 2200
1468	5010	738	2518	10 SEC 2200
1761	6008	886	3023	12 SEC 2200
2202	7515	1107	3777	15 SEC 2200

COLUMN horizontal - 2 column

	450mm	600	12
		800	16
		1000	20
		1200	24
		1400	28
		1800	36
	600mm	600	12
		800	16
		1000	20
		1200	24
		1400	28

435	1485	230	785	12 SEC 2045
580	1980	307	1047	16 SEC 2045
725	2474	384	1310	20 SEC 2045
870	2969	461	1573	24 SEC 2045
1015	3464	538	1836	28 SEC 2045
1305	4454	691	2358	36 SEC 2045
564	1925	298	1017	12 SEC 2060
752	2567	397	1355	16 SEC 2060
940	3209	496	1692	20 SEC 2060
1128	3850	595	2030	24 SEC 2060
1316	4490	694	2368	28 SEC 2060

COLUMN horizontal - 3 column

	300mm	800	16
		1000	20
		1400	28
		1800	36
	450mm	600	12
		800	16
		1000	20
		1200	24
		1400	28
		1800	36

566	1933	299	1020	16 SEC 3030
708	2416	374	1276	20 SEC 3030
991	3382	524	1788	28 SEC 3030
1274	4348	673	2296	36 SEC 3030
605	2064	319	1088	12 SEC 3045
807	2753	426	1454	16 SEC 3045
1009	3443	532	1815	20 SEC 3045
1211	4132	638	2177	24 SEC 3045
1413	4821	745	2542	28 SEC 3045
1818	6203	958	3269	36 SEC 3045

COLUMN

Heat outputs (cont...)

COLUMN horizontal - 3 column (cont...)

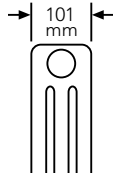
	Nominal Height	Nominal Width (mm)	No. of Sections
	600mm	600	12
		800	16
		1000	20
		1200	24
		1400	28
	750mm	600	12
		800	16
		1000	20
		1200	24
1400		28	

Heat Outputs @ ΔT 50°C		Heat Outputs @ ΔT 30°C		Order Code
Watts	Btu/h	Watts	Btu/h	
780	2661	407	1389	12 SEC 3060
1041	3552	542	1849	16 SEC 3060
1301	4439	678	2313	20 SEC 3060
1561	5326	814	2777	24 SEC 3060
1821	6213	949	3238	28 SEC 3060
952	3248	492	1679	12 SEC 3075
1270	4335	656	2238	16 SEC 3075
1588	5418	820	2798	20 SEC 3075
1905	6500	984	3357	24 SEC 3075
2223	7586	1148	3917	28 SEC 3075

COLUMN horizontal - 4 column

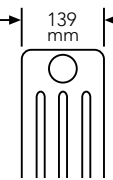
	300mm	800	16
		1000	20
		1400	28
		1800	36
	450mm	600	12
		800	16
		1000	20
		1200	24
		1400	28
		1800	36
	600mm	600	12
		800	16
		1000	20
		1200	24
		1400	28
	750mm	600	12
		800	16
		1000	20
		1200	24
		1400	28

729	2487	386	1317	16 SEC 4030
911	3108	482	1645	20 SEC 4030
1276	4354	675	2303	28 SEC 4030
1640	5596	868	2962	36 SEC 4030
776	2648	404	1378	12 SEC 4045
1035	3531	539	1839	16 SEC 4045
1294	4415	674	2300	20 SEC 4045
1552	5295	809	2760	24 SEC 4045
1811	6179	944	3221	28 SEC 4045
2328	7943	1213	4139	36 SEC 4045
997	3402	515	1757	12 SEC 4060
1329	4537	686	2341	16 SEC 4060
1662	5671	858	2927	20 SEC 4060
1994	6805	1030	3514	24 SEC 4060
2327	7939	1201	4098	28 SEC 4060
1213	4139	620	2115	12 SEC 4075
1618	5521	827	2822	16 SEC 4075
2023	6902	1034	3528	20 SEC 4075
2427	8281	1241	4234	24 SEC 4075
2832	9663	1448	4941	28 SEC 4075

Accessories

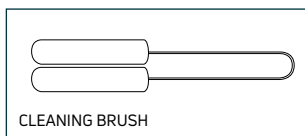

Product	Order Code
Microfibre Cleaning Brush	COLUMNBRUSH2
Towel Rail - Clip-on to fit all radiators up to 1000mm wide (20 sections)	12SECRAIL
	16SECRAIL
	20SECRAIL
Decorative Foot* (not load bearing)	COLDECFOOT
Base-Plate Cover* - For use with both floor brackets	COVERSKFK
Clamped Floor Bracket FK	FK1021

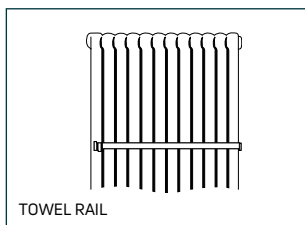

Floor Bracket SK	Height of Bracket (mm)	Height of Radiator (mm)	Order Code
	460	300	SK20046
	610	450	SK20061
	760	600	SK20076
	910	750	SK20091

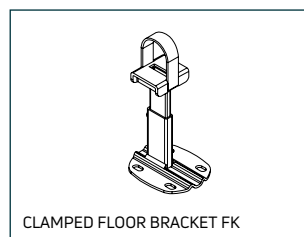
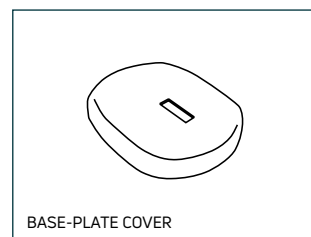
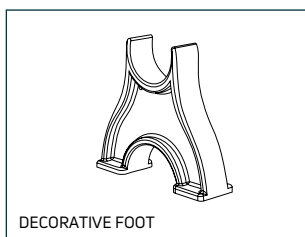

*Supplied in white (RAL 9016) only.