

SERHAD

INS-VS1

ALL MEASUREMENTS ARE IN MILLIMETRES

MANUFACTURED FROM STAINLESS STEEL

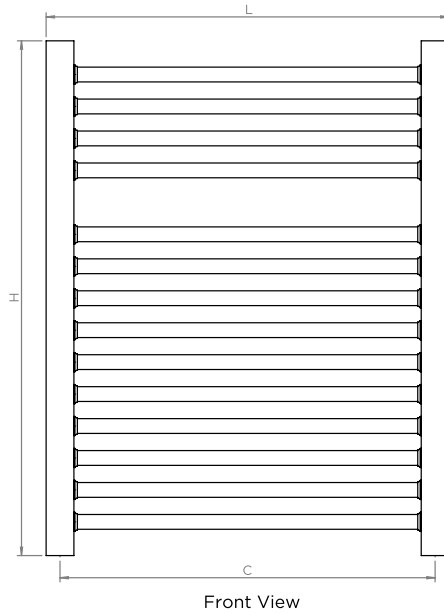
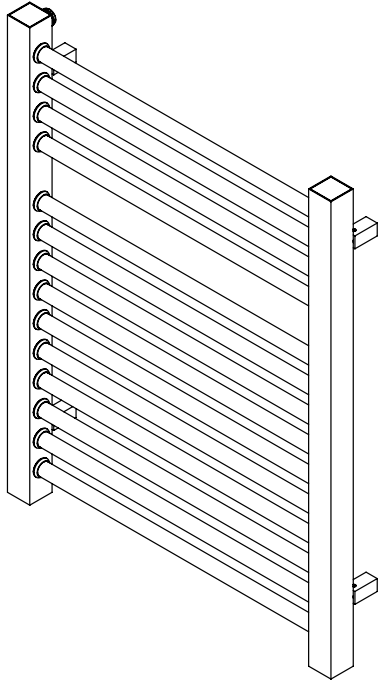

Front View

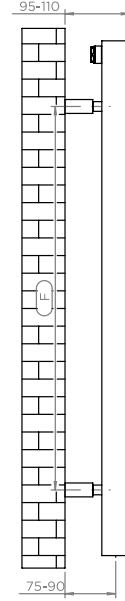

Side View

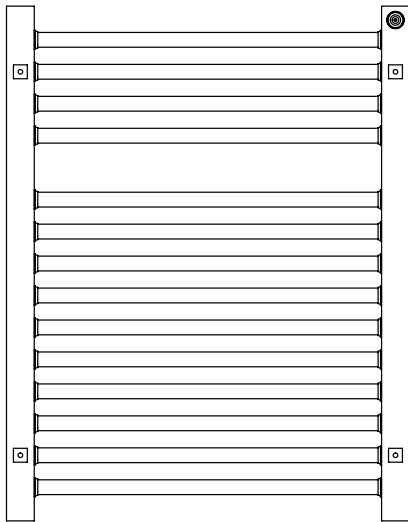

Back View

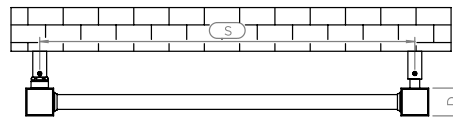

Top View

Installation Accessories:

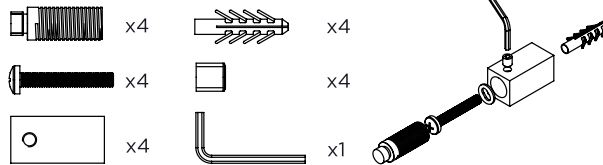

Plumbing Position:

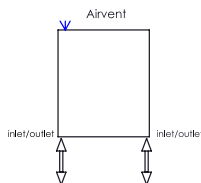

Vertical mount
 All Dimensions are in mm
 Max. Working Pressure: 10 Bar
 Max. Working Temperature: 95° C
 Inlet / Outlet : 1/2" BSP
 Fuel : E/H/D

Manufacturing Tolerance : - 5 mm

PRODUCT CODE	Height	Length	Depth	Pipe Centres	Bracket Centres	
	H	L	D	C	F	S
	mm	mm	mm	mm	mm	mm
CE75-50	750	580	40	540	560	540
CE75-60	750	680	40	640	560	640
CE100-50	1000	580	40	540	810	540
CE100-60	1000	680	40	640	810	640
CE150-50	1500	580	40	540	1310	540
CE150-60	1500	680	40	640	1310	640

Technical specifications are subject to change without prior notice.

AEON is the designer heating division of Pitacs Limited.
 Pitacs Limited, Bradbourne Point, Bradbourne Drive, Tilbrook, Milton Keynes,
 Buckinghamshire, MK7 8AT, UK

T: +44 (0)1908 271155 E: info@pitacs.com W: www.aeon.uk.com

